

SP 320SN
(M0A8)
Parts Catalog

Model	Product Code	PC Style
SP 320DN	M0A7	3D
SP 325DNw	M287	3D
SP 377DNwX	M0BB	3D
SP 320SN	M0A8	3D
SP 325SNw	M288	3D
SP 377SNwX	M0BC	3D
SP 320SFN	M0A9	3D
SP 325SFNw	M289	3D
SP 377SFNwX	M0BD	3D
ARDF	M2891601	Traditional

Unit All

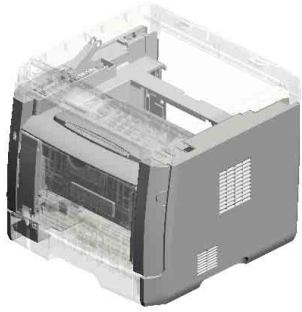

U001
EXTERIOR

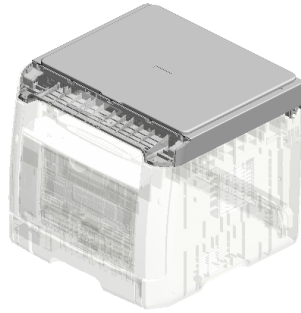

U002
SCANNER



U003
OPERATION

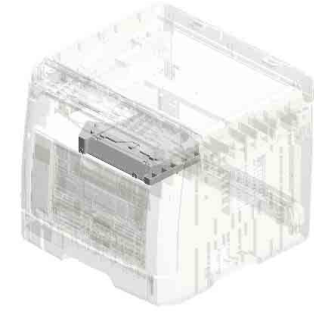

U004
LASER UNIT

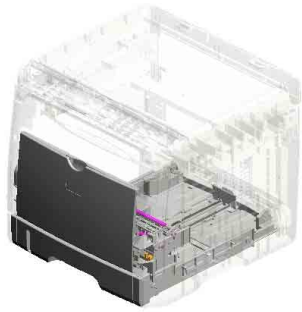

U005
PAPER FEED

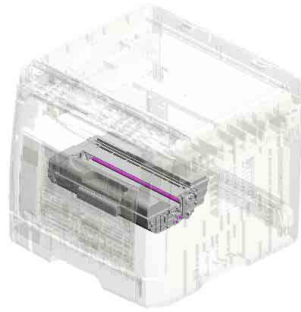

U006
PCU

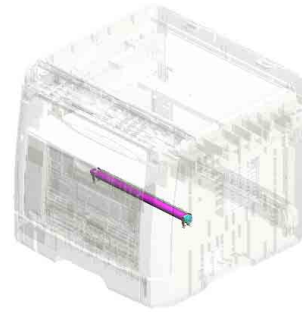

U007
TRANSFER/SEPARATION

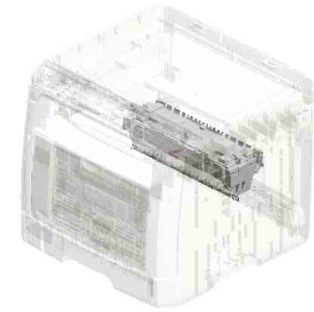

U008
FUSING

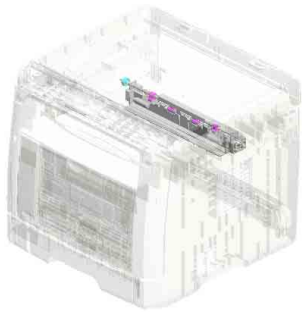

U009
PAPER EXIT

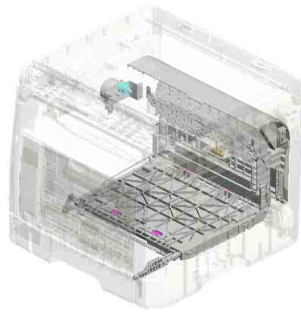

U010
DUPLEX

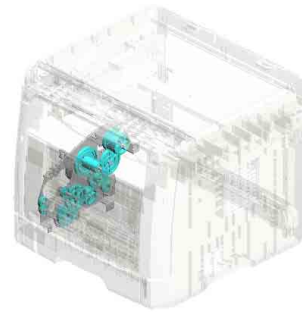

U011
MAIN DRIVE

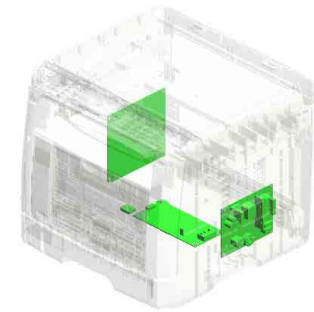

U012
ELECTRICAL

Unit All

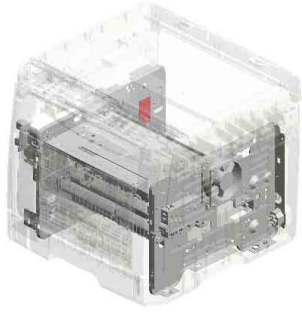

U013
MAIN FRAME

U001 EXTERIOR

- 7.G0521518 SPRING - LOCK LEVER
- 3.04513006N (x6) TAPPING SCREW - 3X6
- 1.04503008N (x2) TAPPING SCREW - M3X8
- 9.M1341382 RAIL:SCANNER:OPEN AND CLOSE
- 15.M1561392 GUIDE PLATE:SCANNER:OPEN AND CLOSE

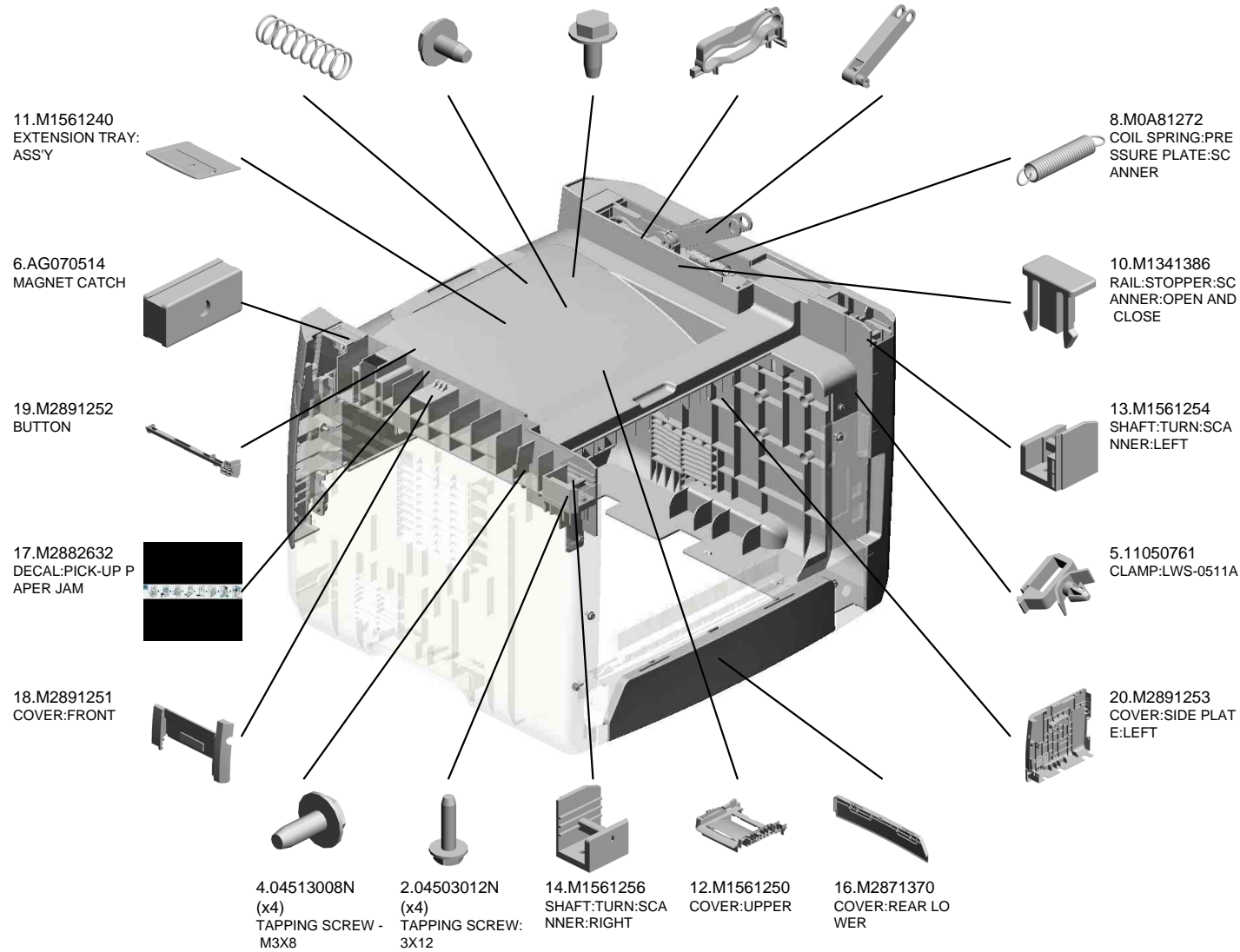
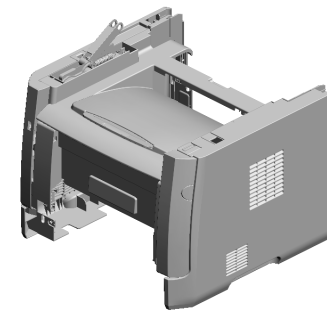

U001
EXTERIOR

21.M2891255
COVER:SIDE PLAT
E:RIGHT

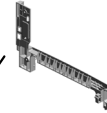
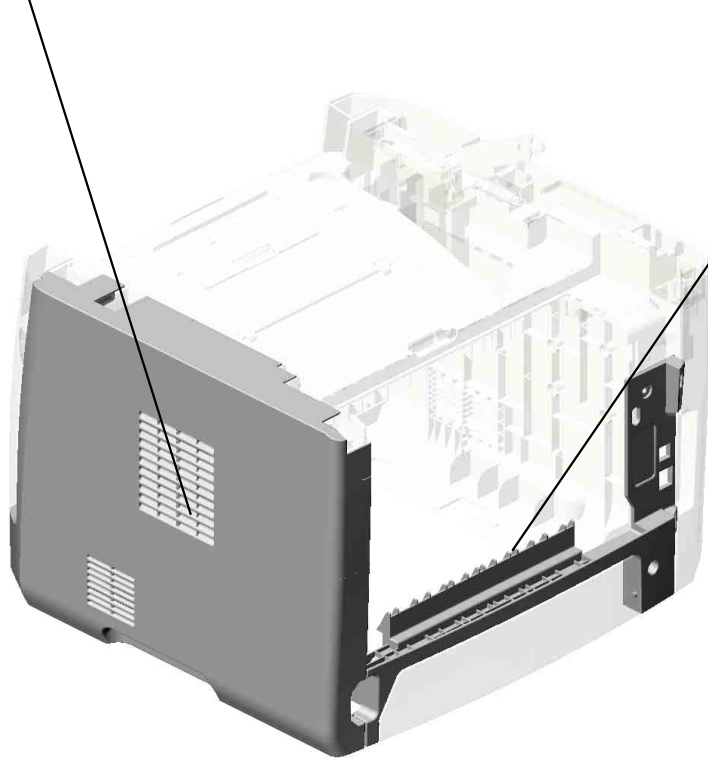

22.M2891259
COVER:REAR MID
DLE:3IN1

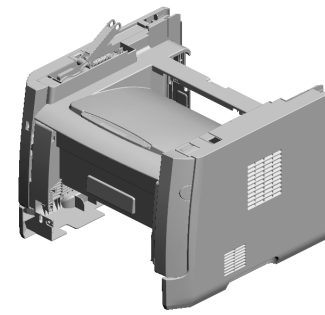

U001	U002	U003	U004	U005	U006	U007	U008	U009	U010	U011	U012	U013
------	------	------	------	------	------	------	------	------	------	------	------	------

U002
SCANNER

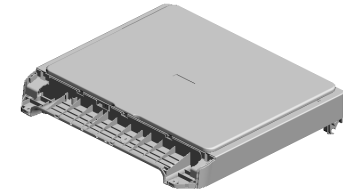

1.M0A80070
SCANNER

U001	U002	U003	U004	U005	U006	U007	U008	U009	U010	U011	U012	U013
------	------	------	------	------	------	------	------	------	------	------	------	------

U003 OPERATION

2.M0A81402
(EU/AA):OPERATIO
N PANEL:ASS'Y

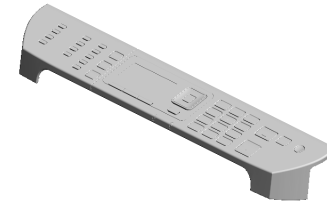

1.04503010N (x 3)
TAPPING SCREW - M3X10

3.M0A81404
(CHN):OPERATION
PANEL:ASS'Y

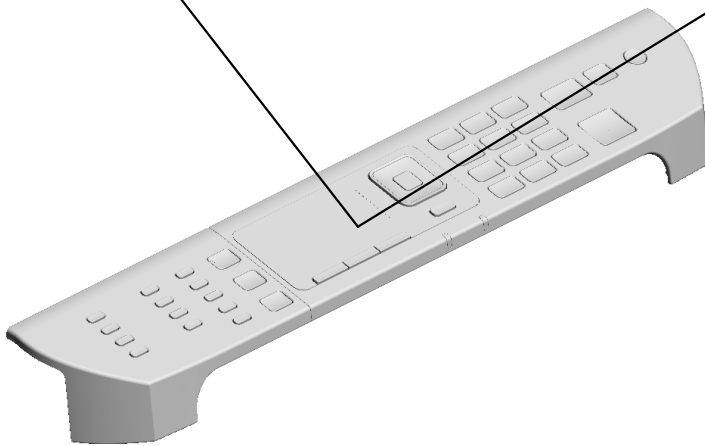

U001	U002	U003	U004	U005	U006	U007	U008	U009	U010	U011	U012	U013
------	------	------	------	------	------	------	------	------	------	------	------	------

U004.LASER UNIT

U004_S001
M0A71851
OPTICAL WRITING UNIT:ASS
Y

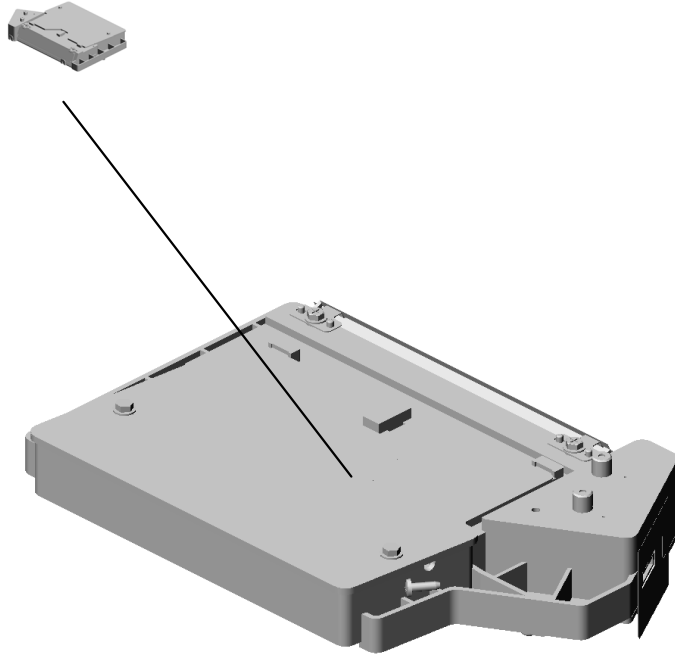

U001	U002	U003	U004	U005	U006	U007	U008	U009	U010	U011	U012	U013
------	------	------	------	------	------	------	------	------	------	------	------	------

U004
LASER UNIT

6.04543008Q
(x3)
TAPPING SCREW:
3X8

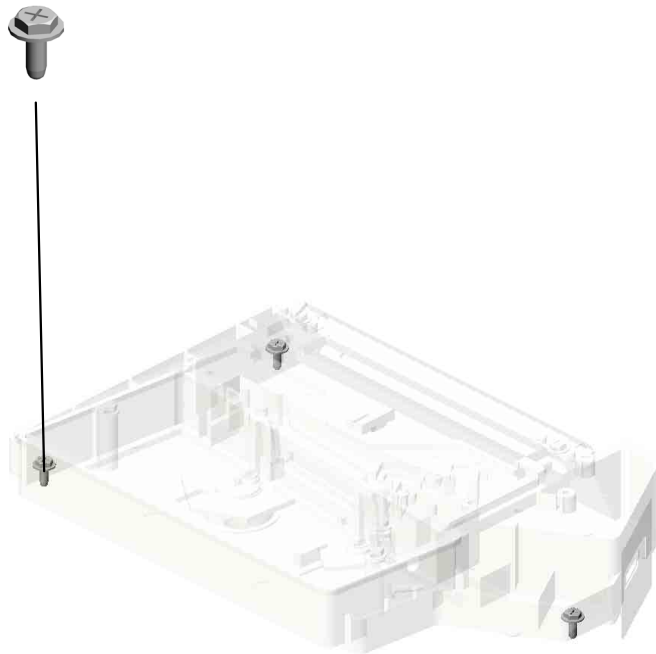
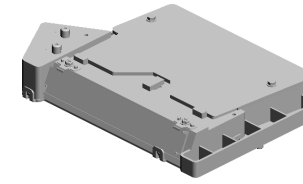

U001	U002	U003	U004	U005	U006	U007	U008	U009	U010	U011	U012	U013
------	------	------	-------------	------	------	------	------	------	------	------	------	------

U004_S001
OPTICAL WRITING UNIT:ASS'Y

3.04513006N
TAPPING SCREW -
3X6

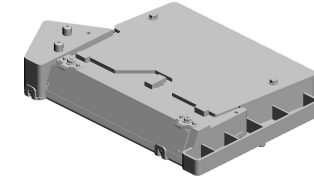

7.M0A71851
OPTICAL WRITING
UNIT:ASSY

4.04523010N
BINDING SELF-TA
PPING SCREW:3X
10

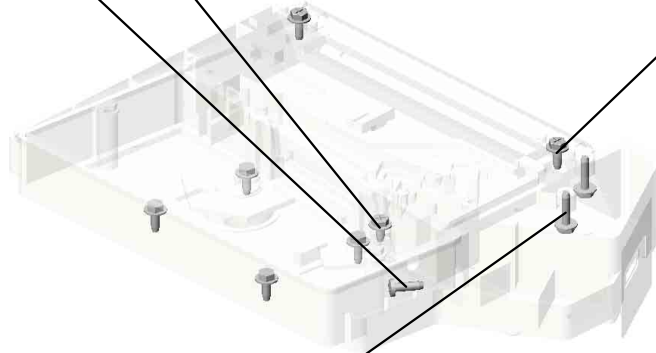
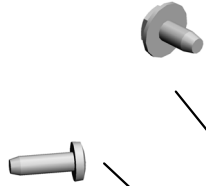

5.04543006Q (x 2)
TAPPING SCREW - M3X6

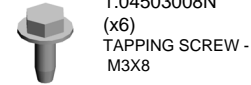

1.04503008N
(x6)
TAPPING SCREW -
M3X8

2.04503012N
(x2)
TAPPING SCREW:
3X12



U001	U002	U003	U004	U005	U006	U007	U008	U009	U010	U011	U012	U013
------	------	------	------	------	------	------	------	------	------	------	------	------

U005.PAPER FEED

U005_S001
M1542505
PAPER TRAY:ASSY

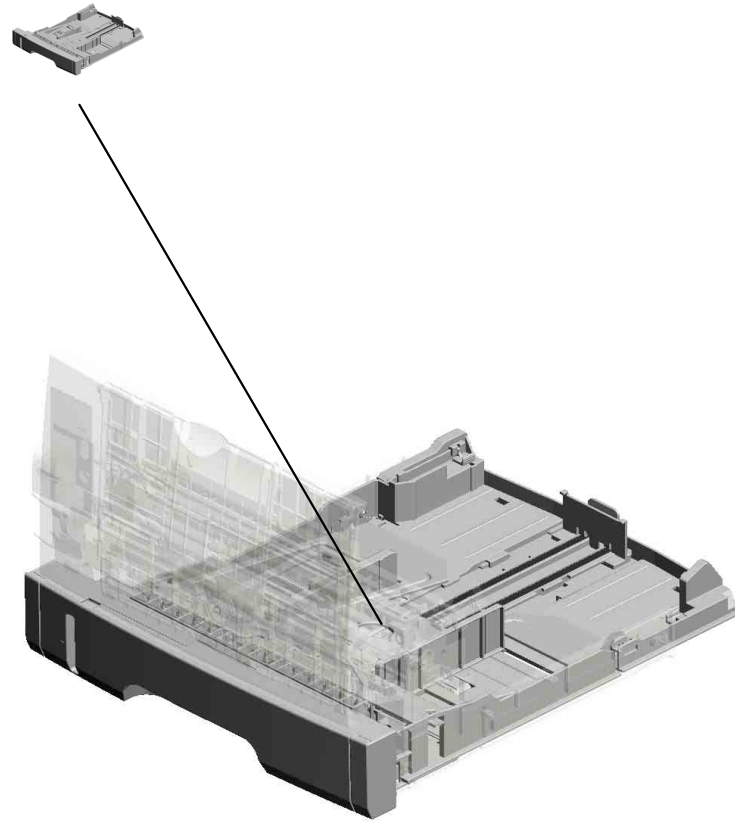

U001	U002	U003	U004	U005	U006	U007	U008	U009	U010	U011	U012	U013
------	------	------	------	-------------	------	------	------	------	------	------	------	------

U005_S001.PAPER TRAY:ASS'Y

U005_S001_S001
M0122610
TRAY BOTTOM PLATE

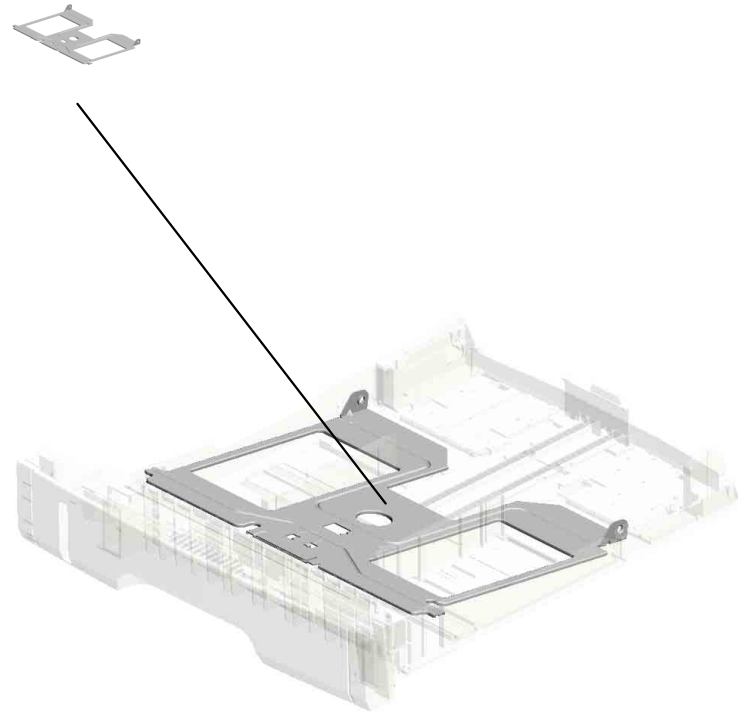

U001	U002	U003	U004	U005	U006	U007	U008	U009	U010	U011	U012	U013
------	------	------	------	-------------	------	------	------	------	------	------	------	------

U005 PAPER FEED

12.G1022717
COVER:DC SOLENOID

10.G0201160
(x2)
SNAP RING

5.A1532117
ROLLER TERMINAL

9.G0123050
SIDE FENCE GEAR

28.M0122668
SHAFT:PAPER FEED ASSY

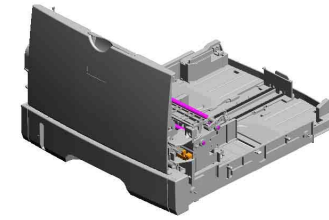

3.04523010N
BINDING SELF-TAPPING SCREW:3X10

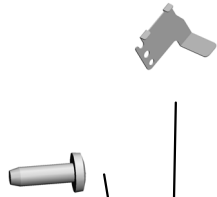

4.08050104
(x7)
RETAINING RINGS -E:SILENCER:DIA4



8.D1272514
(x3)
ELECTROMAGNETIC CLUTCH:3.5T:MANUAL FEED



27.M0122631
CLOTH:EARTH:PA PER FEED



2.04513006N
(x5)
TAPPING SCREW - 3X6



16.GF013001
BOTTOM PLATE PAD

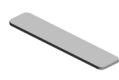

11.G0292767
BY-PASS FEED COVER



29.M0122671
FEELER:PAPER END SENSOR



31.M0122701
ROLLER:INTERFACE:DRIVE



14.G1272627
PAPER FEED ROLLER - MM32



32.M0122702
ROLLER:INTERFACE:DRIVEN



6.AA143520
SHOULDER SCREW - M3

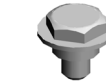

1.04503008N
(x2)
TAPPING SCREW - M3X8



2.04513006N (x 3)
TAPPING SCREW - 3X6

7.AW020198
(x3)
PHOTO INTERRUPTOR:LG2A14NL1

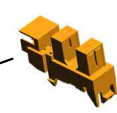

13.G1022789
STOPPER:PHOTO INTERRUPTOR



30.M0122673
RAIL:PAPER TRAY: RIGHT



U005 PAPER FEED

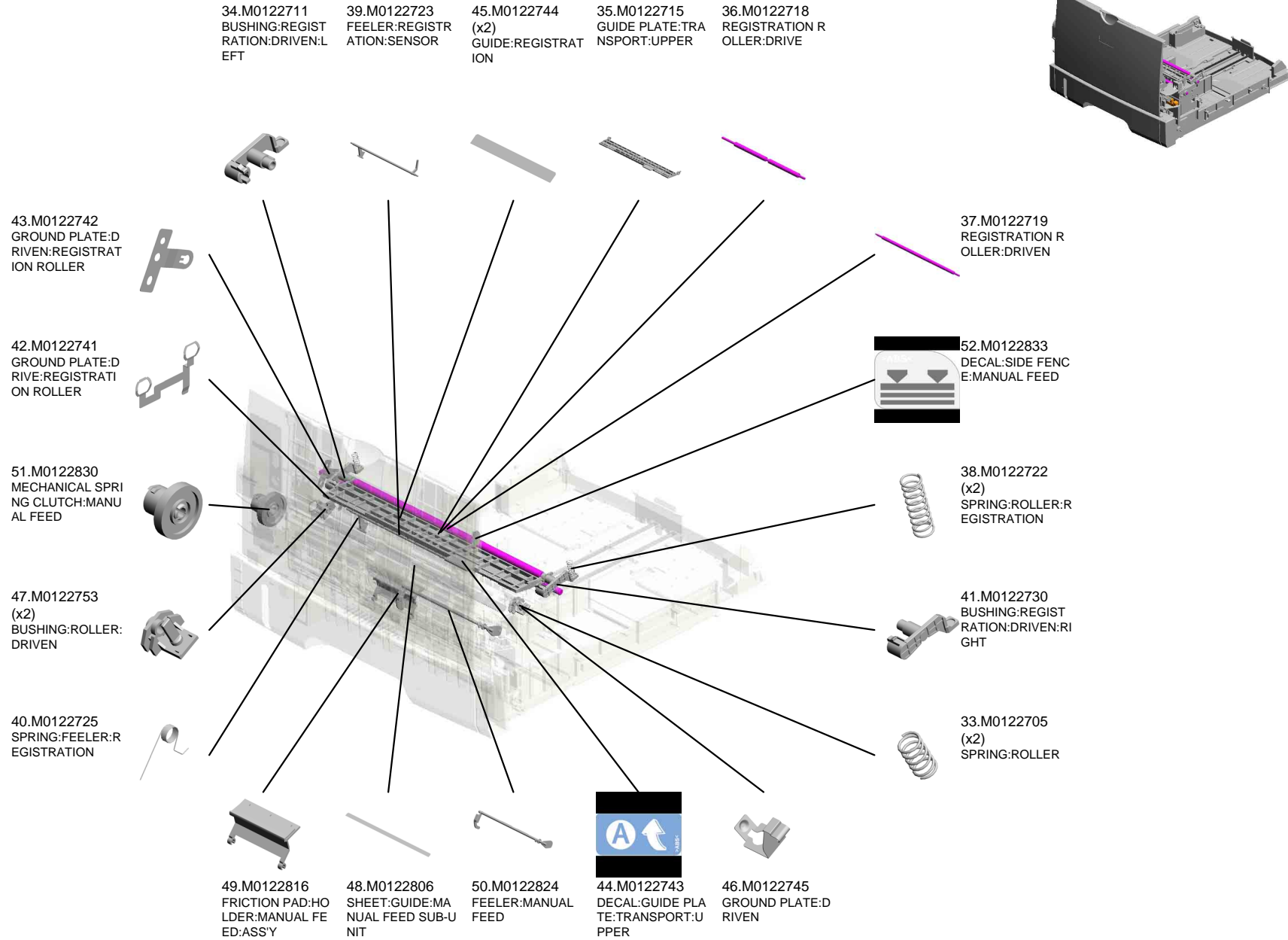

U005 PAPER FEED

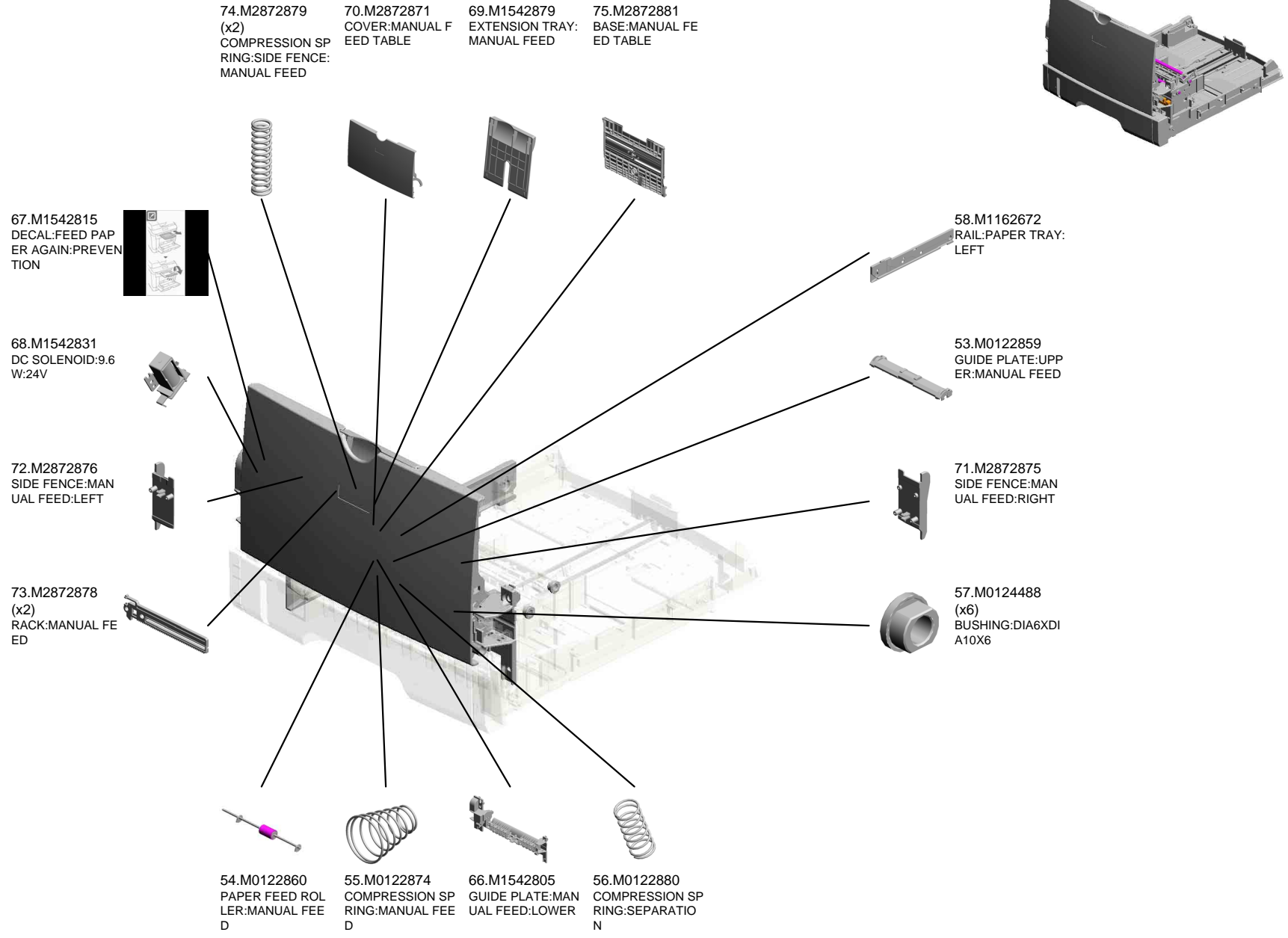

U005_S001
PAPER TRAY:ASS'Y

25.M0122613
COMPRESSION SP
RING:SEPARATIO
N

21.M0122605
FRICTION PAD:AD
HESION

20.M0122604
SPRING:RELEASE:
TRAY BOTTOM PL
ATE

18.M0122590
COIL SPRING:EAR
TH

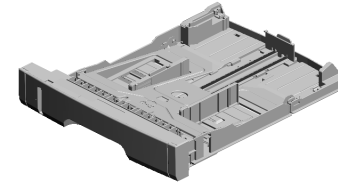

59.M1542505
PAPER TRAY:ASS'
Y

64.M1542640
COVER:PAPER TR
AY:LEFT

62.M1542618
DECAL:PAPER TR
AY:FRONT

61.M1542616
LEVER:PAPER VO
LUME SENSOR

63.M1542629
COVER:PAPER TR
AY:MIDDLE

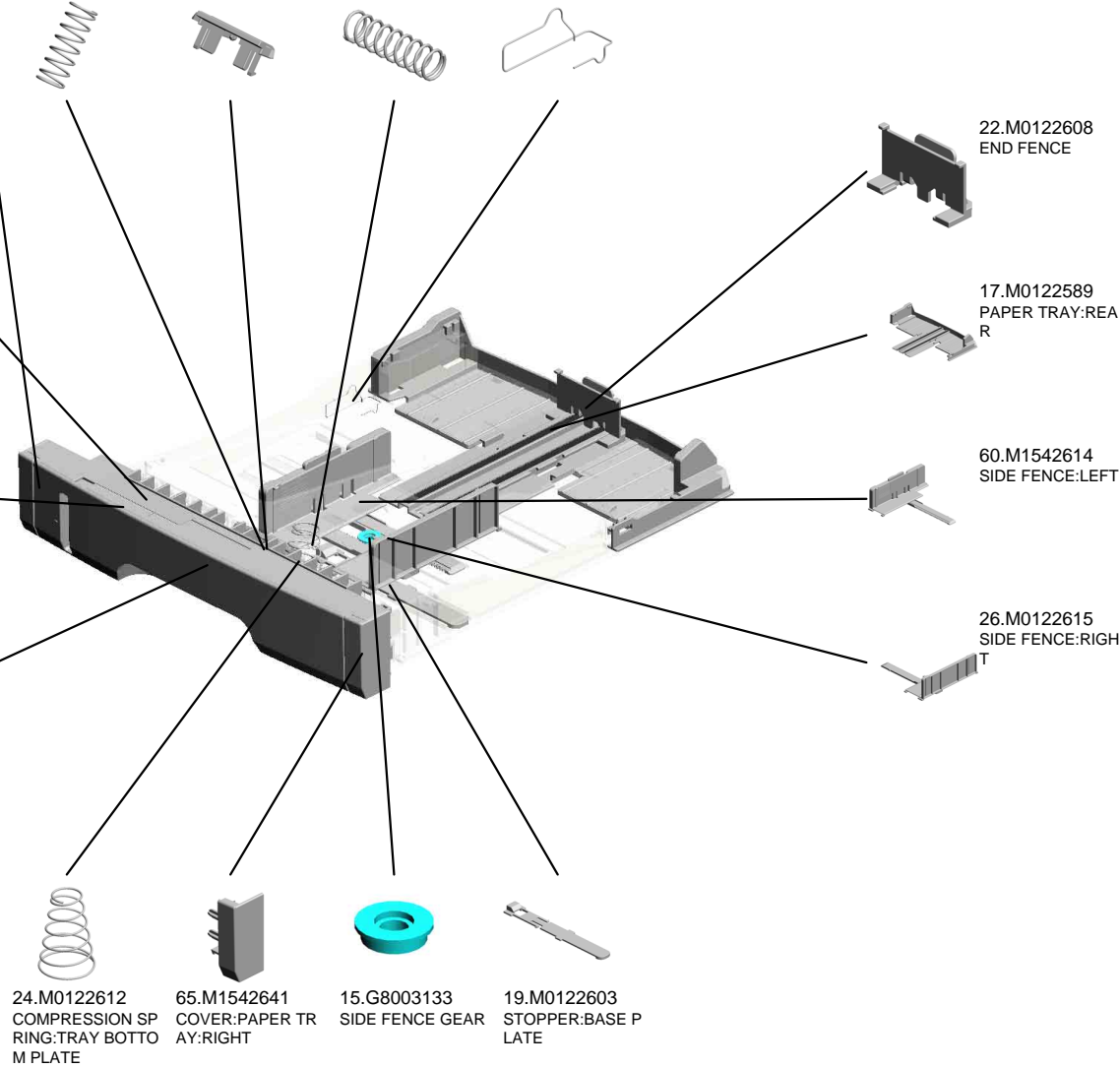

24.M0122612
COMPRESSION SP
RING:TRAY BOTTO
M PLATE

65.M1542641
COVER:PAPER TR
AY:RIGHT

15.G8003133
SIDE FENCE GEAR

19.M0122603
STOPPER:BASE P
LATE

22.M0122608
END FENCE

17.M0122589
PAPER TRAY:REA
R

60.M1542614
SIDE FENCE:LEFT

26.M0122615
SIDE FENCE:RIGH
T

U005_S001_S001
TRAY BOTTOM PLATE

16.GF013001
BOTTOM PLATE P
AD

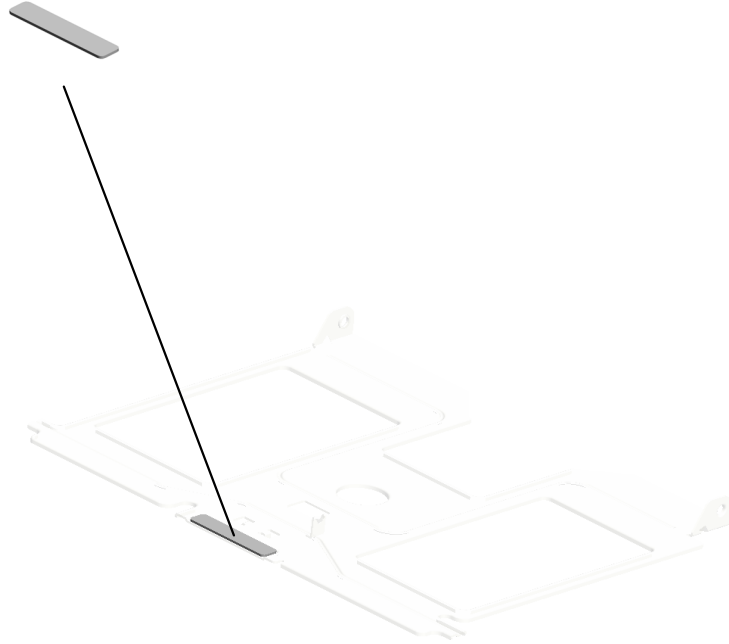

23.M0122610
TRAY BOTTOM PL
ATE

U001	U002	U003	U004	U005	U006	U007	U008	U009	U010	U011	U012	U013
------	------	------	------	------	------	------	------	------	------	------	------	------

U006
PCU

2.04523010N
(x2)
BINDING SELF-TAPPING SCREW:3X
10

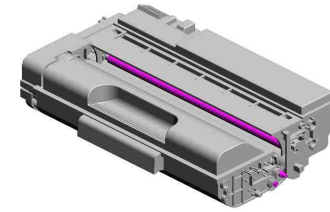
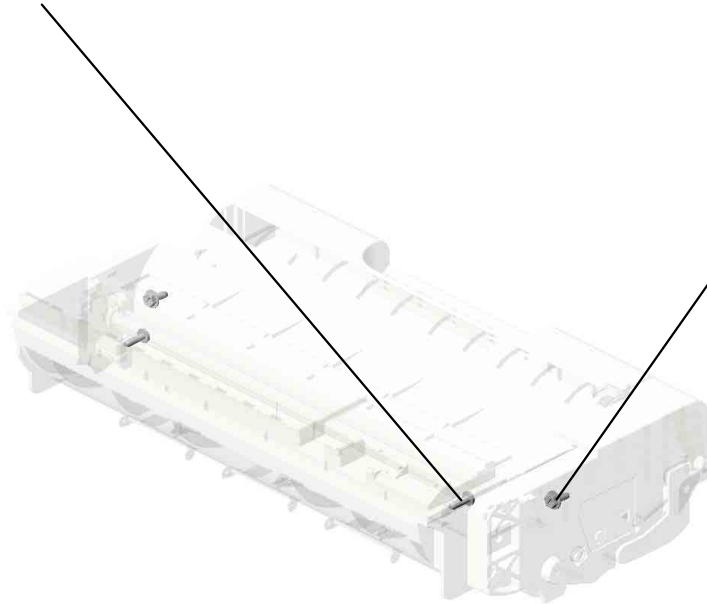

1.04503008N
(x2)
TAPPING SCREW -
M3X8

1.04503008N (x 4)
TAPPING SCREW - M3X8

U001	U002	U003	U004	U005	U006	U007	U008	U009	U010	U011	U012	U013
------	------	------	------	------	-------------	------	------	------	------	------	------	------

U007 TRANSFER/SEPARATION

7.M01016259
ELECTRODE PLAT
E:SEPARATION

5.M0126260
COVER:ELECTRO
DE PLATE

6.M01016250
TRANSFER ROLLE
R

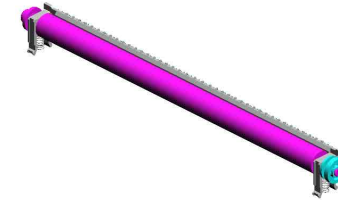

4.M0126256
ROLLER:POSITION
ING:TRANSFER R
OLLER

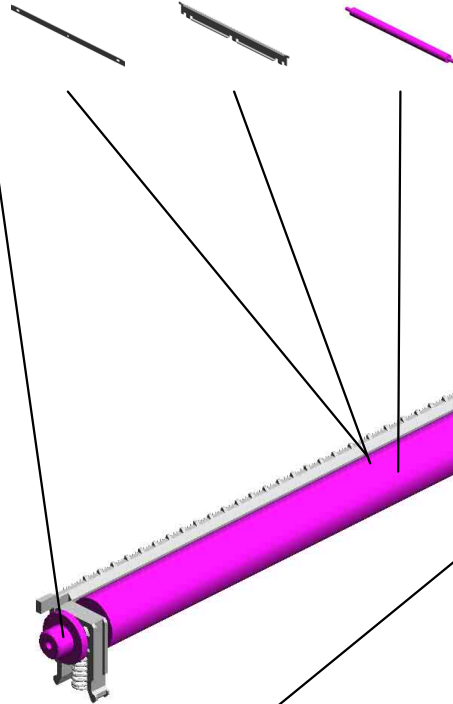

3.M0126255
GEAR:TRANSFER
ROLLER



1.M0126252
(x2)
BUSHING:TRANSF
ER ROLLER:RIGHT



2.M0126254
(x2)
SPRING:TRANSFE
R ROLLER



U001	U002	U003	U004	U005	U006	U007	U008	U009	U010	U011	U012	U013
------	------	------	------	------	------	------	------	------	------	------	------	------

U008.FUSING

U008_S001
M2874031
(EU/AA):FUSING UNIT:ASSY

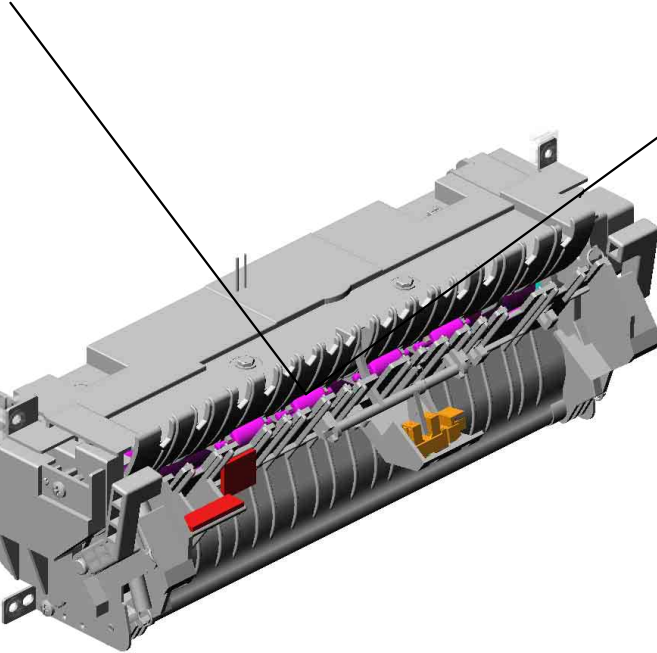
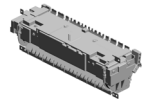

U008_S002
M2874033
(CHN):FUSING UNIT:ASSY

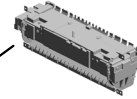

U001	U002	U003	U004	U005	U006	U007	U008	U009	U010	U011	U012	U013
------	------	------	------	------	------	------	------	------	------	------	------	------

U008 FUSING

35.M0124270 (x2)
THERMAL INSULATING BUSHING: FUSING UNIT

4.04513008N (x2)
TAPPING SCREW - M3X8

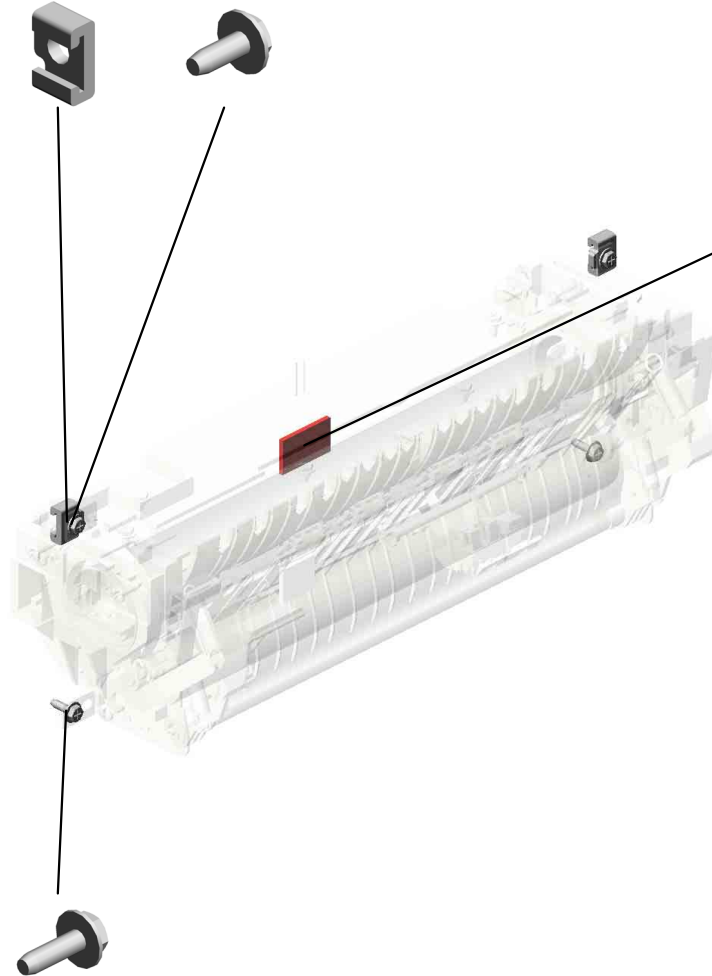
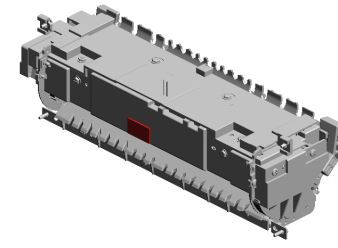

46.M0124699
DECAL: WARNING (HIGH TEMPERATURE): FRONT

2.04503010N (x2)
TAPPING SCREW - M3X10

U001	U002	U003	U004	U005	U006	U007	U008	U009	U010	U011	U012	U013
------	------	------	------	------	------	------	-------------	------	------	------	------	------

U008_S001
(EU/AA):FUSING UNIT:ASS'Y

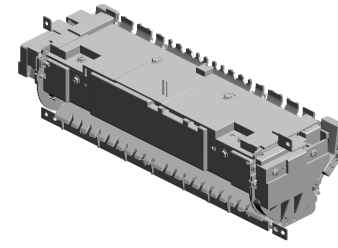

47.M2874031
(EU/AA):FUSING U
NIT:ASSY

8.08046127 (x4) HEXAGONAL BOLT :DOUBLE SCREW: M3X8
 21.M0124204 LEVER:LEFT:FRAM E:FUSING
 17.M0124120 (x3) TENSION SPRING: PICKOFF PAWL
 7.08025318 (x4) BINDING HEAD TA PPING SCREW:ES: 3X10
 19.M0124186 COVER:LEFT UPP ER:ASSY

12.AW110116 THERMOSTAT

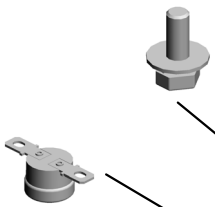

9.09543010N SCREW:POLISHED ROUND/SPRING:M 3X10



10.AA143520 (x7) SHOULDER SCREW - M3



1.03603006N (x11) SCREW - M3X6



13.G1274328 DECAL - HIGH TEM PERATURE



18.M0124135 FEELER:PAPER FE ED SENSOR



16.M0124109 SPRING:FEELER:E XIT



11.AW020198 PHOTOINTERRUP TOR:LG2A14NL1



4.04513008N (x4) TAPPING SCREW - M3X8



20.M0124202 (x2) LEVER:PRESSURE



3.04513006N (x2) TAPPING SCREW - 3X6



14.M0124053 GEAR:HOT ROLLER



15.M0124055 (x2) RADIAL BALL BEA RING:35X47X7



5.04533006N (x6) TAPPING SCREW - M3X6



6.07200040E (x2) RETAINING RING - M4



U008_S001
(EU/AA):FUSING UNIT:ASS'Y

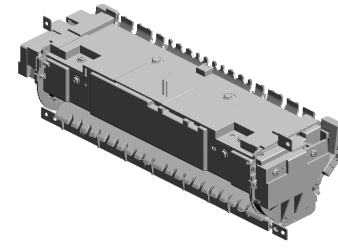

47.M2874031
(EU/AA):FUSING UNIT:ASSY

41.M0124287 COVER:RIGHT UPPER:FUSING
 38.M0124281 (x2) RETAINING RINGS-C:HOT ROLLER
 39.M0124284 LEVER:PRESSURE:LEFT
 25.M0124212 FUSING ENTRANCE GUIDE PLATE:UPPER
 42.M0124292 FUSING COVER:UPPER

22.M0124205 LEVER:RIGHT FRAME:FUSING

31.M0124223 THERMAL INSULATING BUSHING:HOT ROLLER

24.M0124211 PLATE NUT:HEATER

34.M0124266 COVER:RIGHT LOWER:FUSING

26.M0124213 (x2) BUSHING:PRESSURE ROLLER

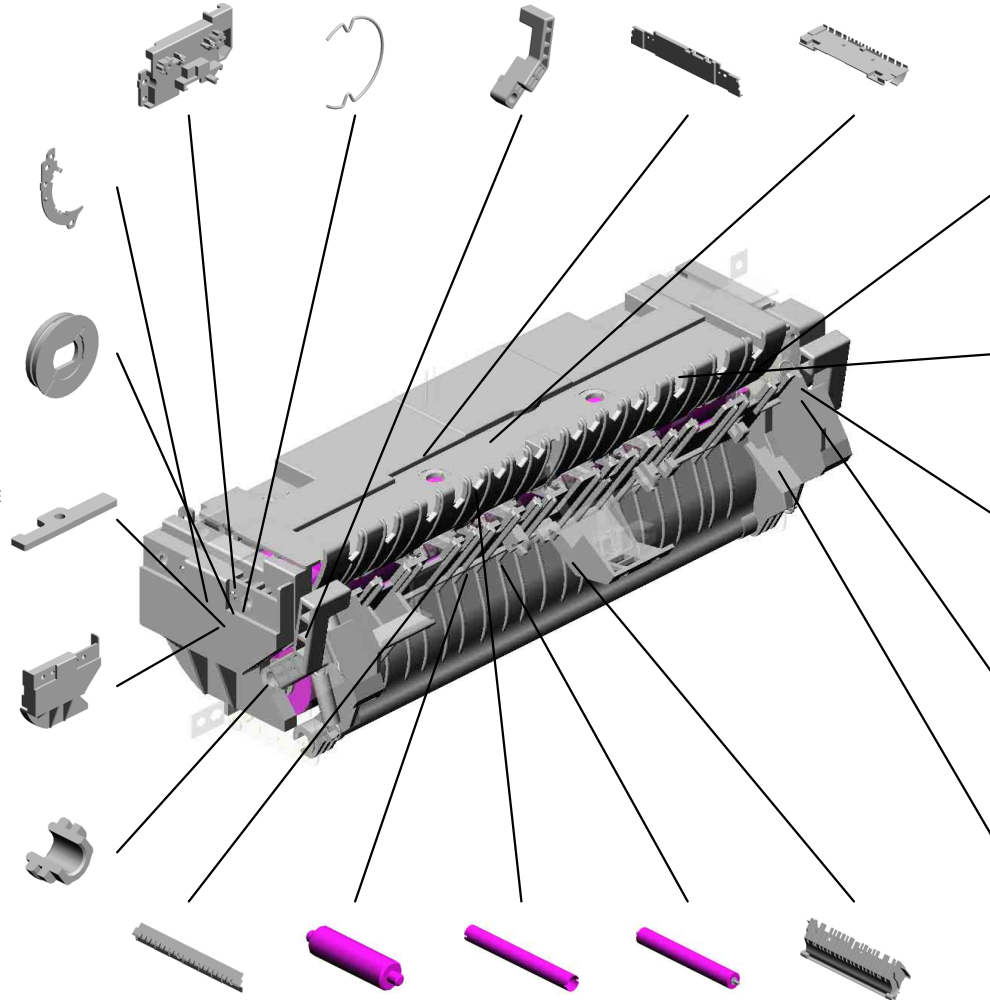

36.M0124276 COVER:LEFT:LOWER:FUSING

23.M0124208 (x3) BRACKET:GATE PLATE

40.M0124285 LEVER:PRESSURE:RIGHT

32.M0124229 (x2) TENSION SPRING:FUSING:PRESSURE

28.M0124216 (x2) TENSION SPRING:FUSING:GUIDE PLATE

29.M0124217 FUSING ENTRANCE GUIDE PLATE:LOWER
 37.M0124279 CLEANING ROLLER:ASSY
 30.M0124220 HOT ROLLER
 33.M0124253 PRESSURE ROLLER:DIA30
 27.M0124215 GUIDE PLATE:EXIT

U008_S001
(EU/AA):FUSING UNIT:ASS'Y

52.M2874263
THERMISTOR

50.M2874221
HEATER:700W:220
V:INFRARED

51.M2874234
HOUSING:THERM
OSTAT:ASS'Y

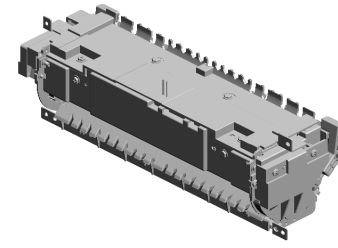

47.M2874031
(EU/AA):FUSING U
NIT:ASS'Y

44.M0124295
GROUND PLATE:A
SS'Y

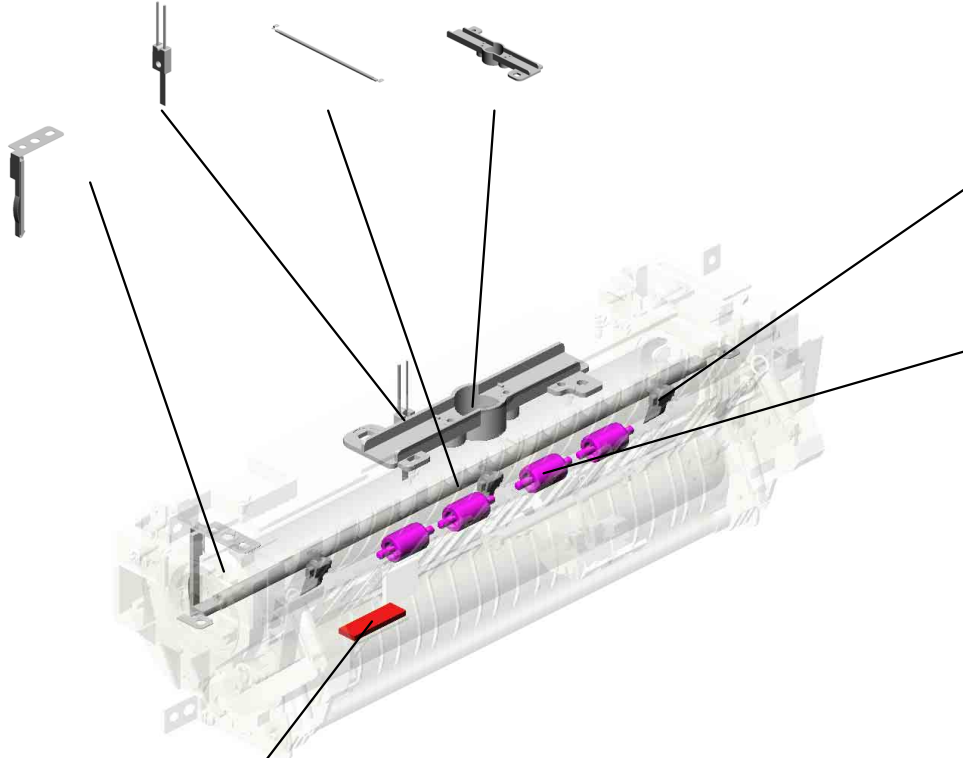

49.M2874206
(x3)
STRIPPER PAWLS

43.M0124293
(x4)
EXIT ROLLER:EXIT
:FUSING



45.M0124603
DECAL:GUIDE PLA
TE:B

U001	U002	U003	U004	U005	U006	U007	U008	U009	U010	U011	U012	U013
------	------	------	------	------	------	------	------	------	------	------	------	------

U008_S002
(CHN):FUSING UNIT:ASS'Y

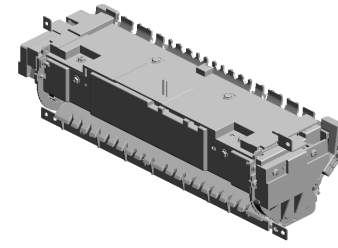

48.M2874033
(CHN):FUSING UNIT:ASS'Y

12.AW110116
THERMOSTAT

21.M0124204
LEVER:LEFT:FRAM
E:FUSING

17.M0124120
(x3)
TENSION SPRING:
PICKOFF PAWL

7.08025318
(x4)
BINDING HEAD TA
PPING SCREW:ES:
3X10

19.M0124186
COVER:LEFT UPP
ER:ASS'Y

8.08046127
(x4)
HEXAGONAL BOLT
:DOUBLE SCREW:
M3X8

9.09543010N
SCREW:POLISHED
ROUND/SPRING:M
3X10

10.AA143520
(x7)
SHOULDER SCRE
W - M3

1.03603006N
(x11)
SCREW - M3X6

13.G1274328
DECAL - HIGH TEM
PERATURE



18.M0124135
FEELER:PAPER FE
ED SENSOR

16.M0124109
SPRING:FEELER:E
XIT

11.AW020198
PHOTOINTERRUP
TOR:LG2A14NL1

4.04513008N
(x4)
TAPPING SCREW -
M3X8

20.M0124202
(x2)
LEVER:PRESSURE

3.04513006N
(x2)
TAPPING SCREW -
3X6

14.M0124053
GEAR:HOT ROLLE
R

15.M0124055
(x2)
RADIAL BALL BEA
RING:35X47X7

5.04533006N
(x6)
TAPPING SCREW -
M3X6

6.07200040E
(x2)
RETAINING RING -
M4

U008_S002
(CHN):FUSING UNIT:ASS'Y

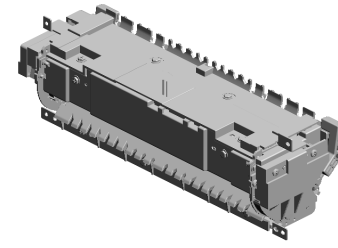

48.M2874033
(CHN):FUSING UNIT:ASS'Y

41.M0124287
COVER:RIGHT UPPER:FUSING

38.M0124281
(x2)
RETAINING RINGS
-C:HOT ROLLER

39.M0124284
LEVER:PRESSURE
:LEFT

25.M0124212
FUSING ENTRANCE
GUIDE PLATE:UPPER

42.M0124292
FUSING COVER:UPPER

22.M0124205
LEVER:RIGHT FRAME:FUSING

31.M0124223
THERMAL INSULATING
BUSHING:HOT ROLLER

24.M0124211
PLATE NUT:HEATER

34.M0124266
COVER:RIGHT LOWER:FUSING

26.M0124213
(x2)
BUSHING:PRESSURE ROLLER

29.M0124217
FUSING ENTRANCE
GUIDE PLATE:LOWER

37.M0124279
CLEANING ROLLER:ASSY

30.M0124220
HOT ROLLER

33.M0124253
PRESSURE ROLLER:DIA30

27.M0124215
GUIDE PLATE:EXIT

36.M0124276
COVER:LEFT LOWER:FUSING

23.M0124208
(x3)
BRACKET:GATE PLATE

40.M0124285
LEVER:PRESSURE:RIGHT

32.M0124229
(x2)
TENSION SPRING:
FUSING:PRESSURE

28.M0124216
(x2)
TENSION SPRING:
FUSING:GUIDE PLATE

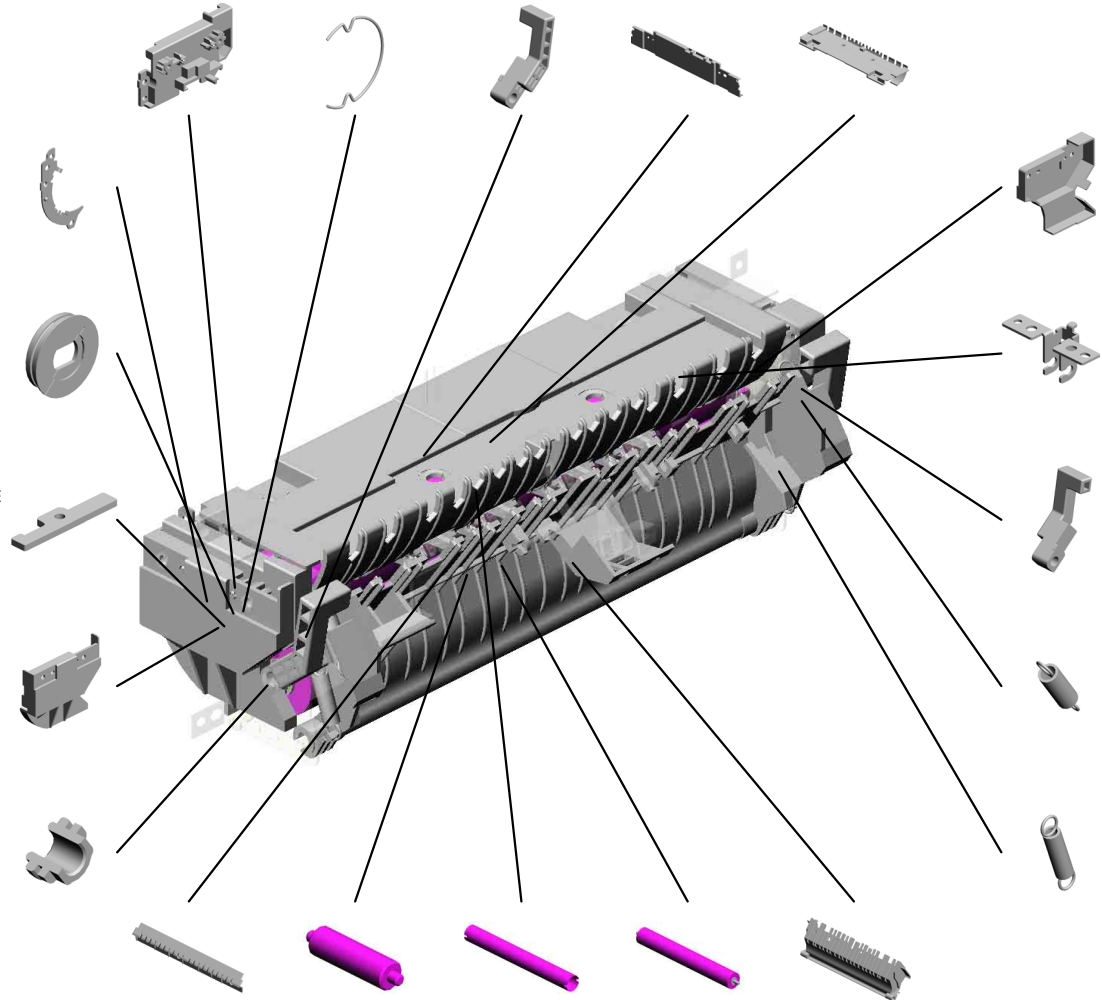

U008_S002
(CHN):FUSING UNIT:ASS'Y

52.M2874263
THERMISTOR

50.M2874221
HEATER:700W:220
V:INFRARED

51.M2874234
HOUSING:THERM
OSTAT:ASS'Y

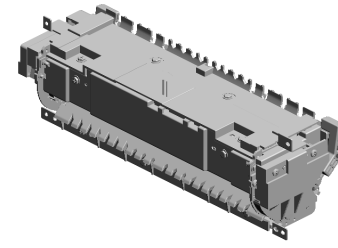

48.M2874033
(CHN):FUSING UNI
T:ASS'Y

44.M0124295
GROUND PLATE:A
SS'Y

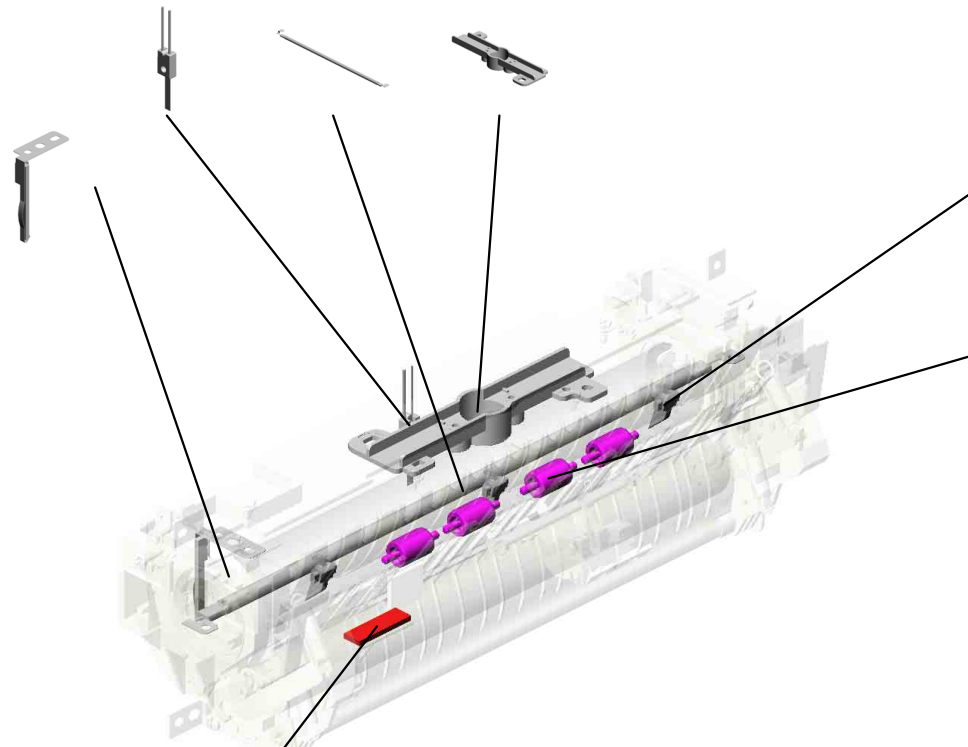

49.M2874206
(x3)
STRIPPER PAWLS

43.M0124293
(x4)
EXIT ROLLER:EXIT
:FUSING



45.M0124603
DECAL:GUIDE PLA
TE:B

U001	U002	U003	U004	U005	U006	U007	U008	U009	U010	U011	U012	U013
------	------	------	------	------	------	------	------	------	------	------	------	------

U009 PAPER EXIT

2.07200040E (x2) RETAINING RING - M4
 6.M0124488 (x2) BUSHING:DIA6XDI A10X6
 8.M0134470 (x2) EXIT ROLLER:DUPLEX

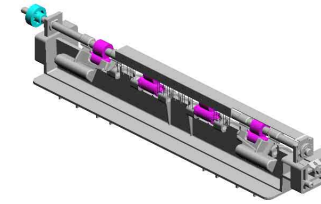

7.M0134455 GEAR:DRIVE:EXIT ROLLER



1.04503008N (x2) TAPPING SCREW - M3X8

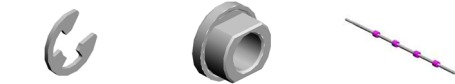

9.M1544499 GROUND PLATE:EXIT ROLLER

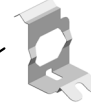

3.M0124453 (x4) EXIT ROLLER



4.M0124454 (x4) SPRING:EXIT ROLLER:EXIT



5.M0124458 DISCHARGE BRUSH:EXIT:ASS'Y DRAWING

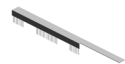

U001	U002	U003	U004	U005	U006	U007	U008	U009	U010	U011	U012	U013
------	------	------	------	------	------	------	------	-------------	------	------	------	------

U010 DUPLEX

- 4.04543006Q (x4) TAPPING SCREW - M3X6
- 10.M0134610 GEAR:DRIVE:DUPL EX
- 6.08050104 (x7) RETAINING RINGS -E:SILENCER:DIA4
- 11.M0134611 BRACKET:DRIVE:D UPLEX:ASS'Y
- 18.M0134664 GUIDE PLATE:VER TICAL TRANSPOR T:UPPER

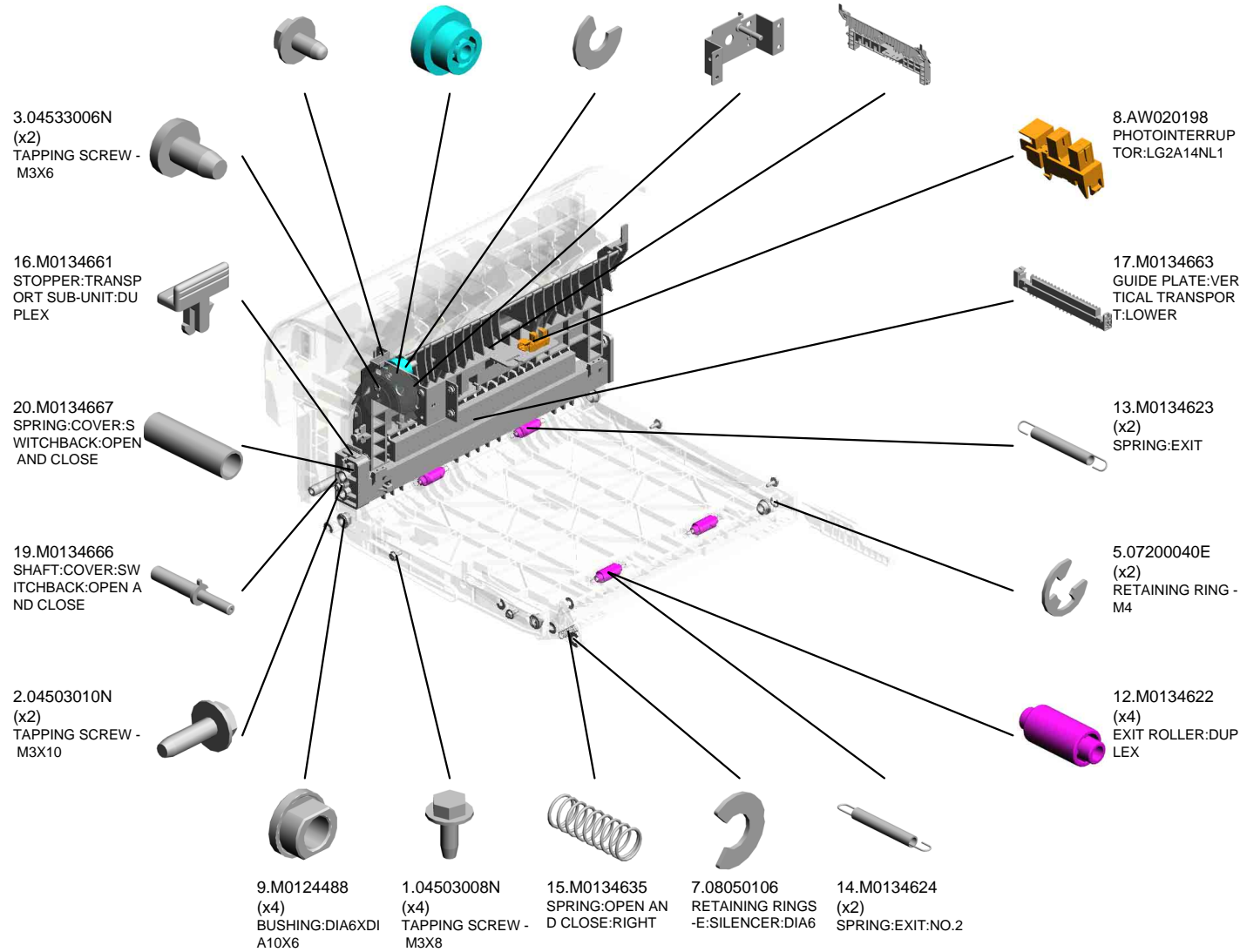
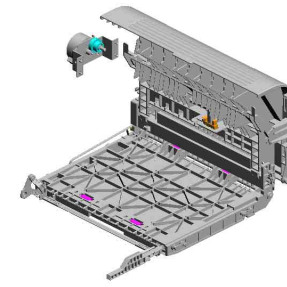

U001	U002	U003	U004	U005	U006	U007	U008	U009	U010	U011	U012	U013
------	------	------	------	------	------	------	------	------	------	------	------	------

U010 DUPLEX

22.M0134669
(x2)
MAGNET CATCH:AS
SY

40.M0134794
DECAL:GUIDE PLA
TE:VERTICAL TRA
NSPORT:UPPER

34.M0134761
TRANSPORT ROLL
ER:DUPLEX:MIDDL
E

27.M0134684
SHEET:DUPLEX

23.M0134671
SHEET:HORIZONT
AL TRANSPORT:LE
FT

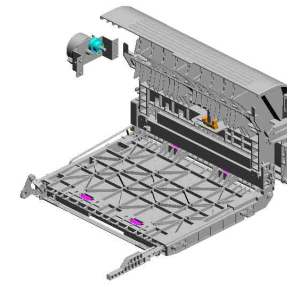

24.M0134672
SHEET:HORIZONT
AL TRANSPORT:RI
GHT

29.M0134688
GROUND PLATE:H
ORIZONTAL TRAN
SPORT:REAR

36.M0134765
(x3)
PULLEY:TRANSP
ORT

38.M0134772
TIMING BELT:DRIV
E

30.M0134691
LEVER:OPEN AND
CLOSE:LOWER

25.M0134673
LEVER:OPEN AND
CLOSE:NO.1

26.M0134674
LEVER:OPEN AND
CLOSE:NO.2

31.M0134696
LEVER:OPEN AND
CLOSE:LEFT

35.M0134762
TRANSPORT ROLL
ER:DUPLEX:EXIT

33.M0134698
BRACKET:OPEN A
ND CLOSE:LOWER

37.M0134771
TIMING BELT:HORI
ZONTAL TRANSP
ORT

21.M0134668
SHEET:GUIDE:HO
RIZONTAL TRAN
SPORT:LOWER

39.M0134785
SPRING:COVER:S
WITCHBACK:OPEN
AND CLOSE

32.M0134697
LEVER:OPEN AND
CLOSE:RIGHT

28.M0134685
BUTTON:OPEN AN
D CLOSE:LOWER

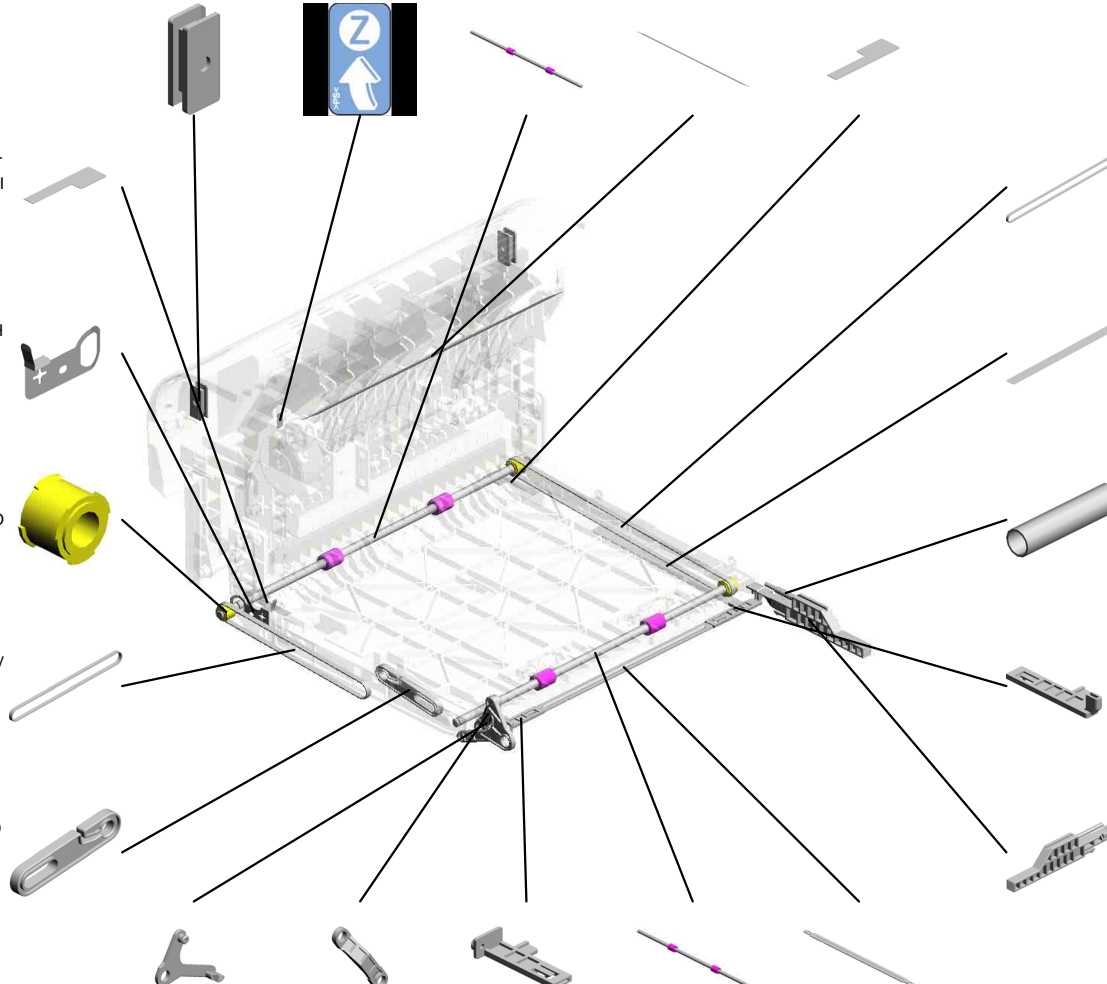

U010 DUPLEX

43.M1540265
STEPPER MOTOR

42.M1174662
COVER:SWITCHBA
CK:OPEN AND CL
OSE

41.M0134797
FEELER:SENSOR:
VERTICAL TRANS
PORT

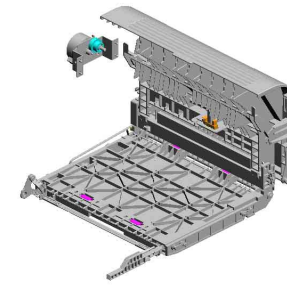

46.M2874719
(x2)
PIN:GUIDE:TRANS
PORT

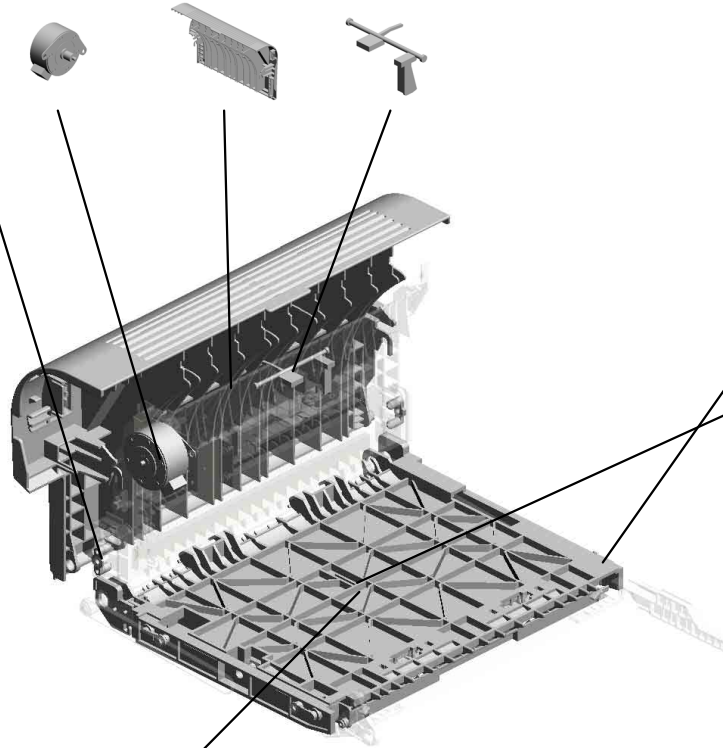

47.M2874895
(x4)
PIN:GUIDE:UPPER

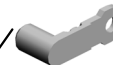

44.M1544694
GUIDE:HORIZONT
AL TRANSPORT:U
PPER

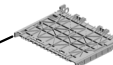

45.M1544695
GUIDE:HORIZONT
AL TRANSPORT:L
OWER



U001	U002	U003	U004	U005	U006	U007	U008	U009	U010	U011	U012	U013
------	------	------	------	------	------	------	------	------	------	------	------	------

U011 MAIN DRIVE

7.11050758 CLAMP:LWSM-030 6A
 11.M0121120 GEAR:DRIVE:FUSI NG:NO.3
 13.M0121128 GEAR:DRIVE:FUSI NG:NO.4
 3.07200040E RETAINING RING - M4
 2.04543006Q TAPPING SCREW - M3X6

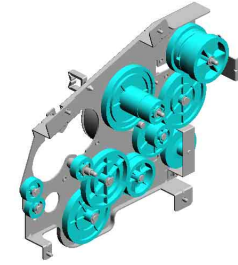

8.G0521120 SPRING - PAPER EXIT RELEASE



4.08050104 (x6) RETAINING RINGS -E:SILENCER:DIA4



10.M0121119 GEAR:DRIVE:FUSI NG:NO.2



9.M0121117 GEAR:DRIVE:DRUM



17.M0131178 BRACKET:DRIVE:DUPLIX



14.M0121150 BRUSHLESS MOTOR:DC 36.7W



18.M1161118 GEAR:DRIVE:FUSI NG:NO.1



19.M1161121 GEAR:DRIVE:PAPER FEED:NO.1



20.M1161122 GEAR:DRIVE:PAPER FEED:NO.2



6.11050568 CLAMP:LWSS-0504



5.11050197 WIRE SADDLE

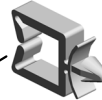

1.04513006N (x10) TAPPING SCREW - 3X6



12.M0121123 GEAR:DRIVE:PAPER FEED:NO.3



16.M0121172 GEAR:DRIVE:MANUAL FEED SECTION:NO.2



15.M0121171 GEAR:DRIVE:MANUAL FEED SECTION:NO.1



U011 MAIN DRIVE

22.M1171136 23.M1541177
GEAR:DRIVE:DUPL CASE:DRIVE:ASS'Y
EX SECTION

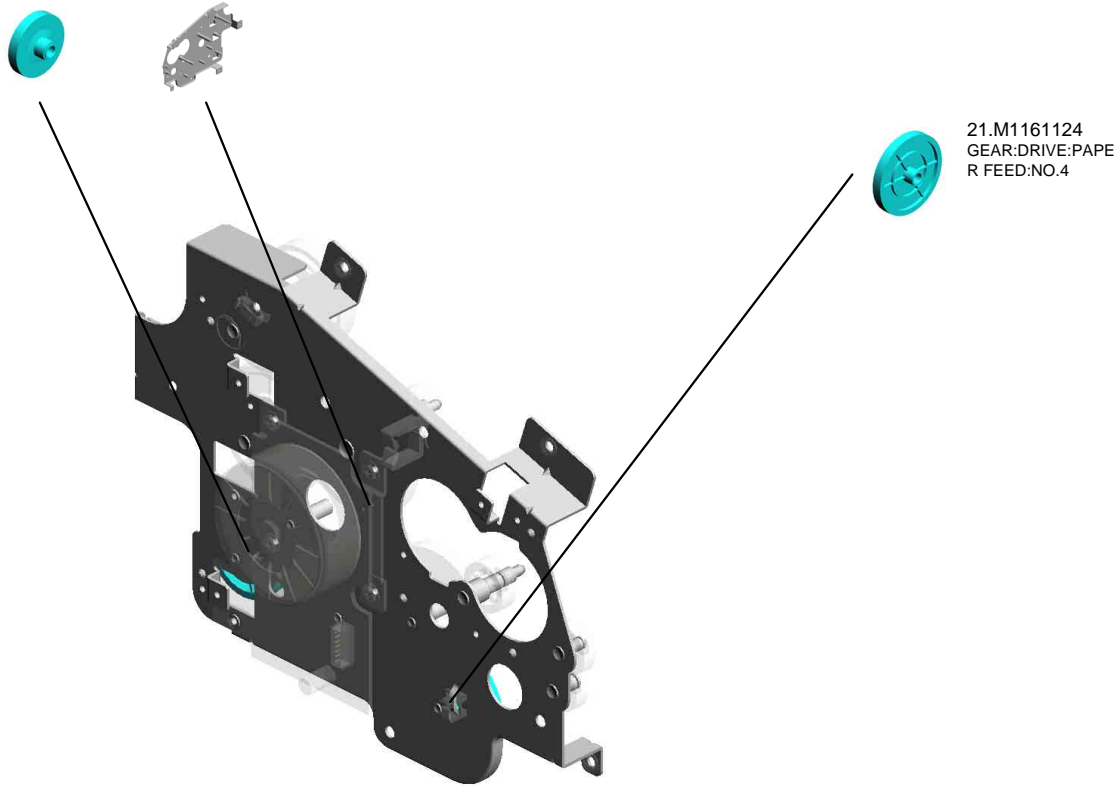
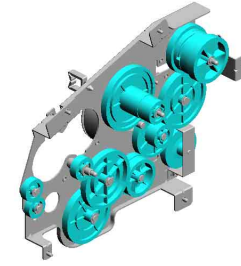

21.M1161124
GEAR:DRIVE:PAPE
R FEED:NO.4

U001	U002	U003	U004	U005	U006	U007	U008	U009	U010	U011	U012	U013
------	------	------	------	------	------	------	------	------	------	------	------	------

U012 ELECTRICAL

5.M1545402
POWER PACK:ASSY

4.M0A85052
PCB:ECBCTL:3IN1:
ASSY

1.04513006N
(x4)
TAPPING SCREW -
3X6

2.04543006Q
(x4)
TAPPING SCREW -
M3X6

3.16072774
FERRITE CORE:K3
FF

7.M2875312
(EU/AA):POWER S
UPPLY UNIT:ASSY

6.M2875311
(CHN):POWER SU
PPLY UNIT:ASSY

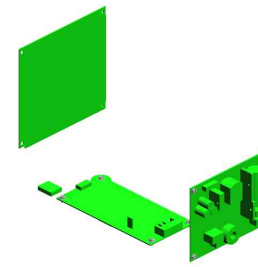
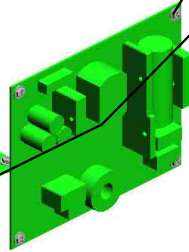
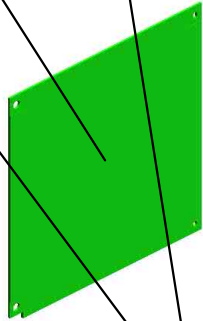
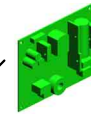
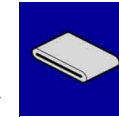

U001	U002	U003	U004	U005	U006	U007	U008	U009	U010	U011	U012	U013
------	------	------	------	------	------	------	------	------	------	------	------	------

U013 MAIN FRAME

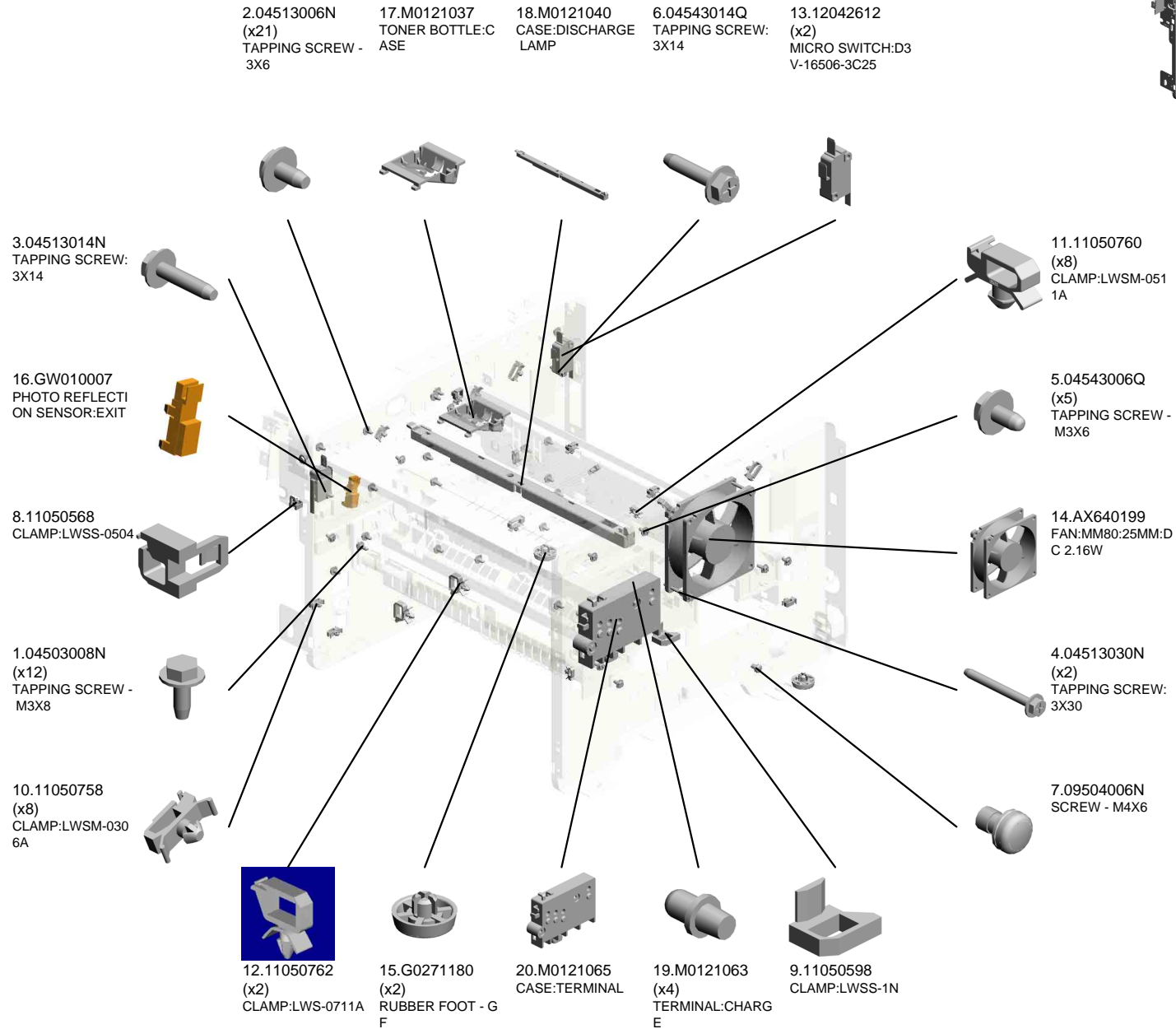
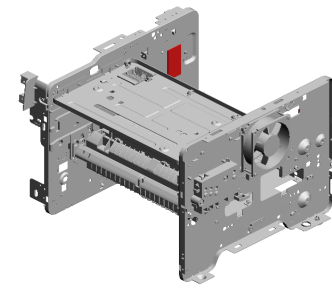

U013 MAIN FRAME

- 23.M0121089 (x3) GUIDE:PAPER:LEADING EDGE
- 24.M0121097 (x3) SUPPORTER:PAPER:TRANSPORT
- 25.M0124120 (x3) TENSION SPRING:PICKOFF PAWL
- 26.M0124601 DECAL:LEVER:ENVELOPE:LEFT

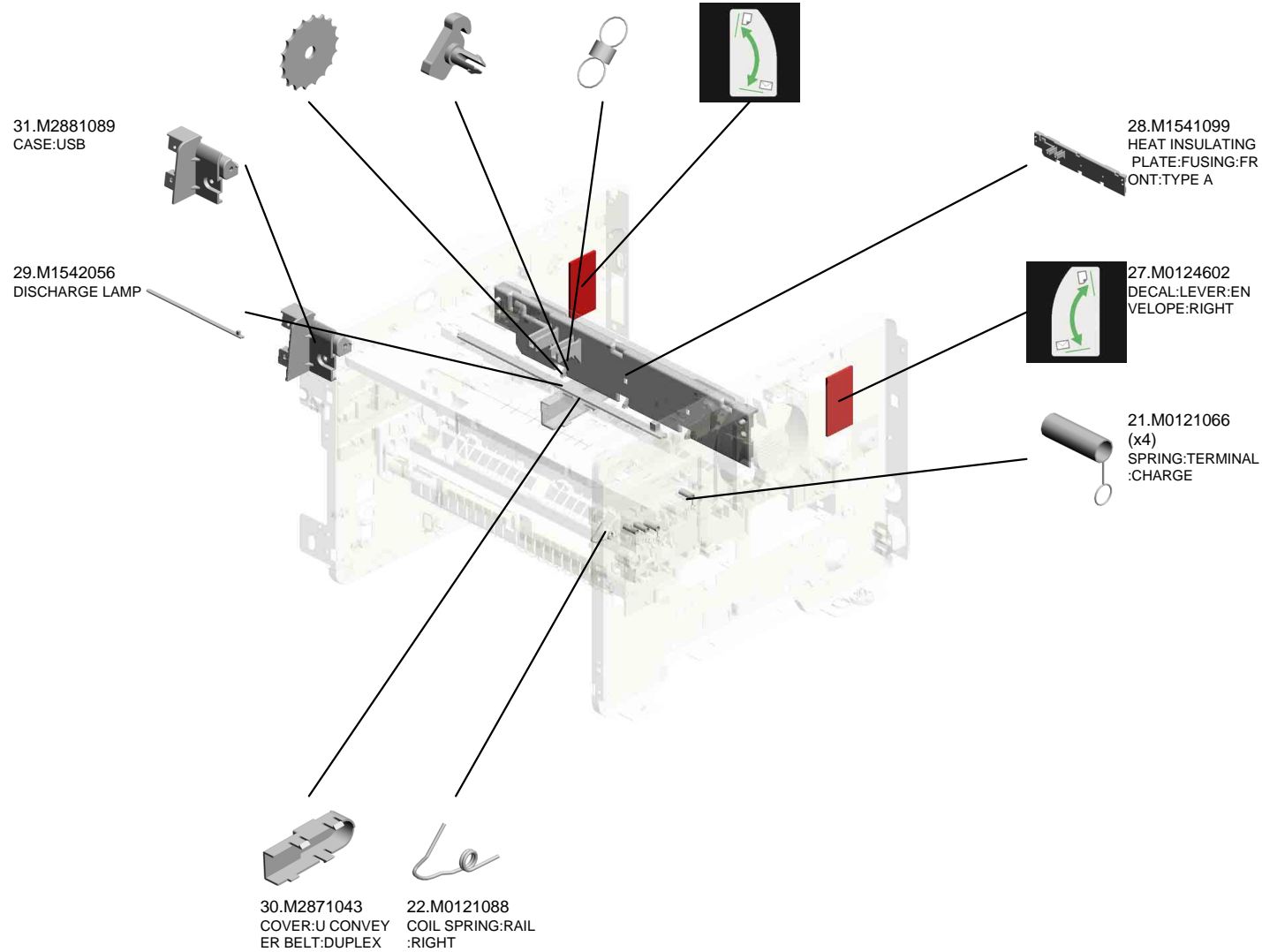
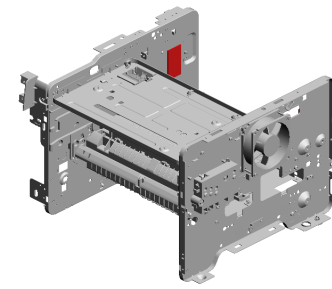

ACCESSORIES



1.M0A80431
MODEL NAME PLATE:SP320SN



2.M1011301
PLATE:LOGO:RIC

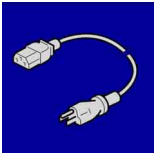

3.M1015799
(CHN):POWER SUPPLY CORD

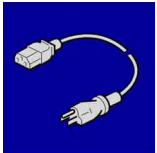

4.M1545699
(EU/AA):POWER SUPPLY CORD:250
V:10A

Exclusive Parts

Number	Part Name	Group	ID
A1532117	ROLLER TERMINAL	U005	5
AA143520	SHOULDER SCREW - M3	U005	6
		U008_S001	10
		U008_S002	10
AG070514	MAGNET CATCH	U001	6
AW020198	PHOTOINTERRUPTOR:LG2A14NL 1	U005	7
		U008_S001	11
		U008_S002	11
		U010	8
AW110116	THERMOSTAT	U008_S001	12
		U008_S002	12
AX640199	FAN:MM80:25MM:DC 2.16W	U013	14
D1272514	ELECTROMAGNETIC CLUTCH:3.5 T:MANUAL FEED	U005	8
G0123050	SIDE FENCE GEAR	U005	9
G0201160	SNAP RING	U005	10
G0271180	RUBBER FOOT - GF	U013	15
G0292767	BY-PASS FEED COVER	U005	11
G0521120	SPRING - PAPER EXIT RELEASE	U011	8
G0521518	SPRING - LOCK LEVER	U001	7
G1022717	COVER:DC SOLENOID	U005	12
G1022789	STOPPER:PHOTOINTERRUPTOR	U005	13
G1272627	PAPER FEED ROLLER - MM32	U005	14
G1274328	DECAL - HIGH TEMPERATURE	U008_S001	13
		U008_S002	13
G8003133	SIDE FENCE GEAR	U005_S001	15
GF013001	BOTTOM PLATE PAD	U005	16
		U005_S001_S001	16
GW010007	PHOTO REFLECTION SENSOR:EXI T	U013	16
M0121037	TONER BOTTLE:CASE	U013	17
M0121040	CASE:DISCHARGE LAMP	U013	18
M0121063	TERMINAL:CHARGE	U013	19
M0121065	CASE:TERMINAL	U013	20
M0121066	SPRING:TERMINAL:CHARGE	U013	21
M0121088	COIL SPRING:RAIL:RIGHT	U013	22
M0121089	GUIDE:PAPER:LEADING EDGE	U013	23
M0121097	SUPPORTER:PAPER:TRANSPORT	U013	24

Number	Part Name	Group	ID
M0121117	GEAR:DRIVE:DRUM	U011	9
M0121119	GEAR:DRIVE:FUSING:NO.2	U011	10
M0121120	GEAR:DRIVE:FUSING:NO.3	U011	11
M0121123	GEAR:DRIVE:PAPER FEED:NO.3	U011	12
M0121128	GEAR:DRIVE:FUSING:NO.4	U011	13
M0121150	BRUSHLESS MOTOR:DC 36.7W	U011	14
M0121171	GEAR:DRIVE:MANUAL FEED SECT ION:NO.1	U011	15
		U011	16
M0121172	GEAR:DRIVE:MANUAL FEED SECT ION:NO.2	U011	16
M0122589	PAPER TRAY:REAR	U005_S001	17
M0122590	COIL SPRING:EARTH	U005_S001	18
M0122603	STOPPER:BASE PLATE	U005_S001	19
M0122604	SPRING:RELEASE:TRAY BOTTOM PLATE	U005_S001	20
		U005_S001	21
M0122605	FRICTION PAD:ADHESION	U005_S001	21
M0122608	END FENCE	U005_S001	22
M0122610	TRAY BOTTOM PLATE	U005_S001_S001	23
M0122612	COMPRESSION SPRING:TRAY BO TTOM PLATE	U005_S001	24
		U005_S001	25
M0122613	COMPRESSION SPRING:SEPARAT ION	U005_S001	25
M0122615	SIDE FENCE:RIGHT	U005_S001	26
M0122631	CLOTH:EARTH:PAPER FEED	U005	27
M0122668	SHAFT:PAPER FEED:ASS'Y	U005	28
M0122671	FEELER:PAPER END SENSOR	U005	29
M0122673	RAIL:PAPER TRAY:RIGHT	U005	30
M0122701	ROLLER:INTERFACE:DRIVE	U005	31
M0122702	ROLLER:INTERFACE:DRIVEN	U005	32
M0122705	SPRING:ROLLER	U005	33
M0122711	BUSHING:REGISTRATION:DRIVEN :LEFT	U005	34
		U005	35
M0122715	GUIDE PLATE:TRANSPORT:UPPE R	U005	35
M0122718	REGISTRATION ROLLER:DRIVE	U005	36
M0122719	REGISTRATION ROLLER:DRIVEN	U005	37
M0122722	SPRING:ROLLER:REGISTRATION	U005	38
M0122723	FEELER:REGISTRATION:SENSOR	U005	39

Exclusive Parts

Number	Part Name	Group	ID
M0122725	SPRING:FEELER:REGISTRATION	U005	40
M0122730	BUSHING:REGISTRATION:DRIVEN:RIGHT	U005	41
M0122741	GROUND PLATE:DRIVE:REGISTRATION ROLLER	U005	42
M0122742	GROUND PLATE:DRIVEN:REGISTRATION ROLLER	U005	43
M0122743	DECAL:GUIDE PLATE:TRANSPORT:UPPER	U005	44
M0122744	GUIDE:REGISTRATION	U005	45
M0122745	GROUND PLATE:DRIVEN	U005	46
M0122753	BUSHING:ROLLER:DRIVEN	U005	47
M0122806	SHEET:GUIDE:MANUAL FEED SUB-UNIT	U005	48
M0122816	FRICTION PAD:HOLDER:MANUAL FEED:ASS'Y	U005	49
M0122824	FEELER:MANUAL FEED	U005	50
M0122830	MECHANICAL SPRING CLUTCH:MANUAL FEED	U005	51
M0122833	DECAL:SIDE FENCE:MANUAL FEED	U005	52
M0122859	GUIDE PLATE:UPPER:MANUAL FEED	U005	53
M0122860	PAPER FEED ROLLER:MANUAL FEED	U005	54
M0122874	COMPRESSION SPRING:MANUAL FEED	U005	55
M0122880	COMPRESSION SPRING:SEPARATION	U005	56
M0124053	GEAR:HOT ROLLER	U008_S001	14
		U008_S002	14
M0124055	RADIAL BALL BEARING:35X47X7	U008_S001	15
		U008_S002	15
M0124109	SPRING:FEELER:EXIT	U008_S001	16
		U008_S002	16
M0124120	TENSION SPRING:PICKOFF PAWL	U008_S001	17
		U008_S002	17
		U013	25

Number	Part Name	Group	ID
M0124135	FEELER:PAPER FEED SENSOR	U008_S001	18
		U008_S002	18
M0124186	COVER:LEFT UPPER:ASS'Y	U008_S001	19
		U008_S002	19
M0124202	LEVER:PRESSURE	U008_S001	20
		U008_S002	20
M0124204	LEVER:LEFT:FRAME:FUSING	U008_S001	21
		U008_S002	21
M0124205	LEVER:RIGHT:FRAME:FUSING	U008_S001	22
		U008_S002	22
M0124208	BRACKET:GATE PAWL	U008_S001	23
		U008_S002	23
M0124211	PLATE NUT:HEATER	U008_S001	24
		U008_S002	24
M0124212	FUSING ENTRANCE GUIDE PLATE:UPPER	U008_S001	25
		U008_S002	25
M0124213	BUSHING:PRESSURE ROLLER	U008_S001	26
		U008_S002	26
M0124215	GUIDE PLATE:EXIT	U008_S001	27
		U008_S002	27
M0124216	TENSION SPRING:FUSING:GUIDE PLATE	U008_S001	28
		U008_S002	28
M0124217	FUSING ENTRANCE GUIDE PLATE:LOWER	U008_S001	29
		U008_S002	29
M0124220	HOT ROLLER	U008_S001	30
		U008_S002	30
M0124223	THERMAL INSULATING BUSHING:HOT ROLLER	U008_S001	31
		U008_S002	31
M0124229	TENSION SPRING:FUSING:PRESSURE	U008_S001	32
		U008_S002	32
M0124253	PRESSURE ROLLER:DIA30	U008_S001	33
		U008_S002	33
M0124266	COVER:RIGHT LOWER:FUSING	U008_S001	34
		U008_S002	34
M0124270	THERMAL INSULATING BUSHING:FUSING UNIT	U008	35
M0124276	COVER:LEFT:LOWER:FUSING	U008_S001	36
		U008_S002	36

Exclusive Parts

Number	Part Name	Group	ID
M0124279	CLEANING ROLLER:ASS'Y	U008_S001	37
		U008_S002	37
M0124281	RETAINING RINGS-C:HOT ROLLER	U008_S001	38
		U008_S002	38
M0124284	LEVER:PRESSURE:LEFT	U008_S001	39
		U008_S002	39
M0124285	LEVER:PRESSURE:RIGHT	U008_S001	40
		U008_S002	40
M0124287	COVER:RIGHT UPPER:FUSING	U008_S001	41
		U008_S002	41
M0124292	FUSING COVER:UPPER	U008_S001	42
		U008_S002	42
M0124293	EXIT ROLLER:EXIT:FUSING	U008_S001	43
		U008_S002	43
M0124295	GROUND PLATE:ASS'Y	U008_S001	44
		U008_S002	44
M0124453	EXIT ROLLER	U009	3
M0124454	SPRING:EXIT ROLLER:EXIT	U009	4
M0124458	DISCHARGE BRUSH:EXIT:ASS'Y DRAWING	U009	5
M0124488	BUSHING:DIA6XDIA10X6	U005	57
		U009	6
		U010	9
M0124601	DECAL:LEVER:ENVELOPE:LEFT	U013	26
M0124602	DECAL:LEVER:ENVELOPE:RIGHT	U013	27
M0124603	DECAL:GUIDE PLATE:B	U008_S001	45
		U008_S002	45
M0124699	DECAL:WARNING (HIGH TEMPERATURE):FRONT	U008	46
M0126252	BUSHING:TRANSFER ROLLER:RIGHT	U007	1
M0126254	SPRING:TRANSFER ROLLER	U007	2
M0126255	GEAR:TRANSFER ROLLER	U007	3
M0126256	ROLLER:POSITIONING:TRANSFER ROLLER	U007	4
M0126260	COVER:ELECTRODE PLATE	U007	5
M0131178	BRACKET:DRIVE:DUPLEX	U011	17
M0134455	GEAR:DRIVE:EXIT ROLLER	U009	7

Number	Part Name	Group	ID
M0134470	EXIT ROLLER:DUPLEX	U009	8
M0134610	GEAR:DRIVE:DUPLEX	U010	10
M0134611	BRACKET:DRIVE:DUPLEX:ASS'Y	U010	11
M0134622	EXIT ROLLER:DUPLEX	U010	12
M0134623	SPRING:EXIT	U010	13
M0134624	SPRING:EXIT:NO.2	U010	14
M0134635	SPRING:OPEN AND CLOSE:RIGHT	U010	15
M0134661	STOPPER:TRANSPORT SUB-UNIT:DUPLEX	U010	16
M0134663	GUIDE PLATE:VERTICAL TRANSPORT:LOWER	U010	17
M0134664	GUIDE PLATE:VERTICAL TRANSPORT:UPPER	U010	18
M0134666	SHAFT:COVER:SWITCHBACK:OPEN AND CLOSE	U010	19
M0134667	SPRING:COVER:SWITCHBACK:OPEN AND CLOSE	U010	20
M0134668	SHEET:GUIDE:HORIZONTAL TRANSPORT:LOWER	U010	21
M0134669	MAGNET CATCH:ASS'Y	U010	22
M0134671	SHEET:HORIZONTAL TRANSPORT:LEFT	U010	23
M0134672	SHEET:HORIZONTAL TRANSPORT:RIGHT	U010	24
M0134673	LEVER:OPEN AND CLOSE:NO.1	U010	25
M0134674	LEVER:OPEN AND CLOSE:NO.2	U010	26
M0134684	SHEET:DUPLEX	U010	27
M0134685	BUTTON:OPEN AND CLOSE:LOWER	U010	28
M0134688	GROUND PLATE:HORIZONTAL TRANSPORT:REAR	U010	29
M0134691	LEVER:OPEN AND CLOSE:LOWER	U010	30
M0134696	LEVER:OPEN AND CLOSE:LEFT	U010	31
M0134697	LEVER:OPEN AND CLOSE:RIGHT	U010	32
M0134698	BRACKET:OPEN AND CLOSE:LOWER	U010	33
M0134761	TRANSPORT ROLLER:DUPLEX:MIDDLE	U010	34

Exclusive Parts

Number	Part Name	Group	ID
M0134762	TRANSPORT ROLLER:DUPLX:EX IT	U010	35
M0134765	PULLEY:TRANSPORT	U010	36
M0134771	TIMING BELT:HORIZONTAL TRAN SPORT	U010	37
M0134772	TIMING BELT:DRIVE	U010	38
M0134785	SPRING:COVER:SWITCHBACK:OP EN AND CLOSE	U010	39
M0134794	DECAL:GUIDE PLATE:VERTICAL T RANSPORT:UPPER	U010	40
M0134797	FEELER:SENSOR:VERTICAL TRAN SPORT	U010	41
M0A71851	OPTICAL WRITING UNIT:ASS'Y	U004_S001	7
M0A80070	SCANNER	U002	1
M0A80431	MODEL NAME PLATE:SP320SN	ACCESSORIES	1
M0A81272	COIL SPRING:PRESSURE PLATE: SCANNER	U001	8
M0A81402	(EU/AA):OPERATION PANEL:ASS'Y	U003	2
M0A81404	(CHN):OPERATION PANEL:ASS'Y	U003	3
M0A85052	PCB:ECBCTL:3IN1:ASS'Y	U012	4
M1011301	PLATE:LOGO:RIC	ACCESSORIES	2
M1015799	(CHN):POWER SUPPLY CORD	ACCESSORIES	3
M1016250	TRANSFER ROLLER	U007	6
M1016259	ELECTRODE PLATE:SEPARATION	U007	7
M1161118	GEAR:DRIVE:FUSING:NO.1	U011	18
M1161121	GEAR:DRIVE:PAPER FEED:NO.1	U011	19
M1161122	GEAR:DRIVE:PAPER FEED:NO.2	U011	20
M1161124	GEAR:DRIVE:PAPER FEED:NO.4	U011	21
M1162672	RAIL:PAPER TRAY:LEFT	U005	58
M1171136	GEAR:DRIVE:DUPLX SECTION	U011	22
M1174662	COVER:SWITCHBACK:OPEN AND CLOSE	U010	42
M1341382	RAIL:SCANNER:OPEN AND CLOSE	U001	9
M1341386	RAIL:STOPPER:SCANNER:OPEN A ND CLOSE	U001	10
M1540265	STEPPER MOTOR	U010	43
M1541099	HEAT INSULATING PLATE:FUSING :FRONT:TYPE A	U013	28

Number	Part Name	Group	ID
M1541177	CASE:DRIVE:ASS'Y	U011	23
M1542056	DISCHARGE LAMP	U013	29
M1542505	PAPER TRAY:ASS'Y	U005_S001	59
M1542614	SIDE FENCE:LEFT	U005_S001	60
M1542616	LEVER:PAPER VOLUME SENSOR	U005_S001	61
M1542618	DECAL:PAPER TRAY:FRONT	U005_S001	62
M1542629	COVER:PAPER TRAY:MIDDLE	U005_S001	63
M1542640	COVER:PAPER TRAY:LEFT	U005_S001	64
M1542641	COVER:PAPER TRAY:RIGHT	U005_S001	65
M1542805	GUIDE PLATE:MANUAL FEED:LOW ER	U005	66
M1542815	DECAL:FEED PAPER AGAIN:PREV ENTION	U005	67
M1542831	DC SOLENOID:9.6W:24V	U005	68
M1542879	EXTENSION TRAY:MANUAL FEED	U005	69
M1544499	GROUND PLATE:EXIT ROLLER	U009	9
M1544694	GUIDE:HORIZONTAL TRANSPORT :UPPER	U010	44
M1544695	GUIDE:HORIZONTAL TRANSPORT :LOWER	U010	45
M1545402	POWER PACK:ASS'Y	U012	5
M1545699	(EU/AA):POWER SUPPLY CORD:25 0V:10A	ACCESSORIES	4
M1561240	EXTENSION TRAY:ASS'Y	U001	11
M1561250	COVER:UPPER	U001	12
M1561254	SHAFT:TURN:SCANNER:LEFT	U001	13
M1561256	SHAFT:TURN:SCANNER:RIGHT	U001	14
M1561392	GUIDE PLATE:SCANNER:OPEN AN D CLOSE	U001	15
M2871043	COVER:U CONVEYER BELT:DUPL EX	U013	30
M2871370	COVER:REAR LOWER	U001	16
M2872871	COVER:MANUAL FEED TABLE	U005	70
M2872875	SIDE FENCE:MANUAL FEED:RIGH T	U005	71
M2872876	SIDE FENCE:MANUAL FEED:LEFT	U005	72
M2872878	RACK:MANUAL FEED	U005	73
M2872879	COMPRESSION SPRING:SIDE FEN	U005	74

Exclusive Parts

Number	Part Name	Group	ID
	CE:MANUAL FEED		
M2872881	BASE:MANUAL FEED TABLE	U005	75
M2874031	(EU/AA):FUSING UNIT:ASS'Y	U008_S001	47
M2874033	(CHN):FUSING UNIT:ASS'Y	U008_S002	48
M2874206	STRIPPER PAWLS	U008_S001	49
		U008_S002	49
M2874221	HEATER:700W:220V:INFRARED	U008_S001	50
		U008_S002	50
M2874234	HOUSING:THERMOSTAT:ASS'Y	U008_S001	51
		U008_S002	51
M2874263	THERMISTOR	U008_S001	52
		U008_S002	52
M2874719	PIN:GUIDE:TRANSPORT	U010	46
M2874895	PIN:GUIDE:UPPER	U010	47
M2875311	(CHN):POWER SUPPLY UNIT:ASS'Y	U012	6
M2875312	(EU/AA):POWER SUPPLY UNIT:ASS'Y	U012	7
M2881089	CASE:USB	U013	31
M2882632	DECAL:PICK-UP PAPER JAM	U001	17
M2891251	COVER:FRONT	U001	18
M2891252	BUTTON	U001	19
M2891253	COVER:SIDE PLATE:LEFT	U001	20
M2891255	COVER:SIDE PLATE:RIGHT	U001	21
M2891259	COVER:REAR MIDDLE:3IN1	U001	22

Standard Parts



03603006N
SCREW - M3X6

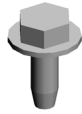

04503008N
TAPPING SCREW - M3X8



04503010N
TAPPING SCREW - M3X10



04503012N
TAPPING SCREW:3X12

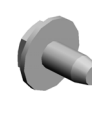

04513006N
TAPPING SCREW - 3X6



04513008N
TAPPING SCREW - M3X8

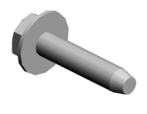

04513014N
TAPPING SCREW:3X14



04513030N
TAPPING SCREW:3X30



04523010N
BINDING SELF-TAPPING SCREW:3X10

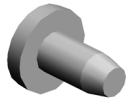

04533006N
TAPPING SCREW - M3X6



04543006Q
TAPPING SCREW - M3X6



04543008Q
TAPPING SCREW:3X8

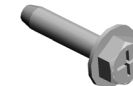

04543014Q
TAPPING SCREW:3X14



07200040E
RETAINING RING - M4



08025318
BINDING HEAD TAPPING SCREW:ES:3X10

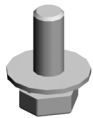

08046127
HEXAGONAL BOLT:DOUBLE SCREW:M3X8



08050104
RETAINING RINGS-E:SILENCER:DIA4



08050106
RETAINING RINGS-E:SILENCER:DIA6



09504006N
SCREW - M4X6



09543010N
SCREW:POLISHED ROUND/SPRING:M3X10



11050197
WIRE SADDLE



11050568
CLAMP:LWSS-0504



11050598
CLAMP:LWSS-1N



11050758
CLAMP:LWSM-0306A

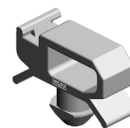

11050760
CLAMP:LWSM-0511A



11050761
CLAMP:LWS-0511A



11050762
CLAMP:LWS-0711A



12042612
MICRO SWITCH:D3V-16506-3C25

Standard Parts

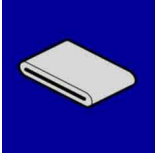

16072774
FERRITE CORE:K3 FF

